

# INSTALLATION INSTRUCTIONS **Panasonic**<sup>®</sup>

## Air Conditioner

This air conditioner uses the refrigerant R32 or R410A.

In case of using R32, confirm the room space and the amount of refrigerant in advance. Install the optional “R32 refrigerant leakage detection sensor” as needed. (See Section “Check of Density Limit”.)

### Model No.

Indoor Units		Rated Capacity					
Type	Indoor Units Type	15	22	28	36	45	56
Y3	4-Way Cassette 60 × 60	S-15MY3E	S-22MY3E	S-28MY3E	S-36MY3E	S-45MY3E	S-56MY3E
(CZ-KPY4)*							

\* Panel (optional parts)



### ENGLISH

Read through the Installation Instructions before you proceed with the installation.  
In particular, you will need to read under the “IMPORTANT!” section at the top of the page.

## IMPORTANT!

### Please Read Before Starting

This air conditioner must be installed by the sales dealer or installer.

This information is provided for use only by authorized persons.

#### For safe installation and trouble-free operation, you must:

- This Installation Instructions is for the indoor unit and read the Installation Instructions of the outdoor unit as well.
- Carefully read this instruction booklet before beginning.
- This air conditioner is required to have the remote controller which is adaptable to nanoe™ X function.
- Follow each installation or repair step exactly as shown.
- This air conditioner shall be installed in accordance with National Wiring Regulations.
- That compliance with national gas regulations shall be observed.
- The product meets the technical requirements of EN/IEC 61000-3-3.



#### WARNING

- Do not use means to accelerate the defrosting process or to clean, other than those recommended by the manufacturer.
- The appliance shall be stored in a room without continuously operating ignition sources (for example: open flames, an operating gas appliance or an operating electric heater).
- Do not pierce or burn.
- Be aware that refrigerants may not contain an odour.
- The following checks shall be applied to installations using flammable refrigerants.  
Appliance shall be installed, operated and stored in a room with a floor area larger than [Amin] m<sup>2</sup>.  
As for [Amin], see Section “Check of Density Limit”.

- Pay close attention to all warning and caution notices given in this manual.



#### WARNING

This symbol refers to a hazard or unsafe practice which can result in severe personal injury or death.



#### CAUTION

This symbol refers to a hazard or unsafe practice which can result in personal injury or product or property damage.

#### If Necessary, Get Help

These instructions are all you need for most installation sites and maintenance conditions. If you require help for a special problem, contact our sales/service outlet or your certified dealer for additional instructions.

#### In Case of Improper Installation

The manufacturer shall in no way be responsible for improper installation or maintenance service, including failure to follow the instructions in this document.

## SPECIAL PRECAUTIONS



#### WARNING When Wiring



**ELECTRICAL SHOCK CAN CAUSE SEVERE PERSONAL INJURY OR DEATH. ONLY A QUALIFIED, EXPERIENCED ELECTRICIAN SHOULD ATTEMPT TO WIRE THIS SYSTEM.**

- Do not supply power to the unit until all wiring and tubing are completed or reconnected and checked.
- Highly dangerous electrical voltages are used in this system. Carefully refer to the wiring diagram and these instructions when wiring. Improper connections and inadequate grounding can cause **accidental injury or death**.
- Connect all wiring tightly. Loose wiring may cause overheating at connection points and a possible fire hazard.
- Provide a power outlet to be used exclusively for each unit.
- Provide a power outlet exclusively for each unit, and full disconnection means having a contact separation by 3 mm in all poles must be incorporated in the fixed wiring in accordance with the wiring rules.
- To prevent possible hazards from insulation failure, the unit must be grounded. 

- Check that cabling will not be subject to wear, corrosion, excessive pressure, vibration, sharp edges or any other adverse environmental effects.  
The check shall also take into account the effects of aging or continual vibration from sources such as compressors or fans.
- This equipment is strongly recommended to be installed with Earth Leakage Circuit Breaker (ELCB) or Residual Current Device (RCD). Otherwise, it may cause electrical shock and fire in case of equipment breakdown or insulation breakdown.

### **When Transporting**

---

- It may need two or more people to carry out the installation work.
- Be careful when picking up and moving the indoor and outdoor units. Get a partner to help, and bend your knees when lifting to reduce strain on your back. Sharp edges or thin aluminum fins on the air conditioner can cut your fingers.

### **When Storing...**

---

#### **WARNING**

- The appliance shall be stored in a well-ventilated area where the room size corresponds to the room area as specified for operation.
- The appliance shall be stored in a room without continuously operating open flames (for example: an operating gas appliance) and ignition sources (for example: an operating electric heater).
- The appliance shall be stored so as to prevent mechanical damage from occurring.

### **When Installing...**

---

- Select an installation location which is rigid and strong enough to support or hold the unit, and select a location for easy maintenance.
- In cases that require mechanical ventilation, ventilation openings shall be kept clear of obstruction.
- An unventilated area where the appliance using flammable refrigerants is installed shall be so constructed that should any refrigerant leak, it will not stagnate so as to create a fire or explosion hazard.

#### **...In a Room**

Properly insulate any tubing run inside a room to prevent “sweating” that can cause dripping and water damage to walls and floors.

 **CAUTION** Keep the fire alarm and the air outlet at least 1.5 m away from the unit.

#### **...In Moist or Uneven Locations**

Use a raised concrete pad or concrete blocks to provide a solid, level foundation for the outdoor unit. This prevents water damage and abnormal vibration.

#### **...In an Area with High Winds**

Securely anchor the outdoor unit down with bolts and a metal frame. Provide a suitable air baffle.

#### **...In a Snowy Area (for Heat Pump-type Systems)**

Install the outdoor unit on a raised platform that is higher than drifting snow. Provide snow vents.

#### **...At Least 2.2 m**

Installation height for indoor unit shall be at least 2.2 m.

#### **...In Laundry Rooms**

Do not install in laundry rooms. Indoor unit is not drip proof.

### **When Connecting Refrigerant Tubing**

---

Pay particular attention to refrigerant leakages.



## WARNING

- When performing piping work, do not mix air except for specified refrigerant in refrigeration cycle. It causes capacity down, and risk of explosion and injury due to high tension inside the refrigerant cycle.
- If the refrigerant comes in contact with a flame, it produces toxic gases and fires.
- Do not add or replace refrigerant other than specified type. It may cause product damage, burst and injury, etc.
- Ventilate the room immediately in the event of a refrigerant gas leakage during installation. Be careful not to allow contact of the refrigerant gas with a flame as this will cause the generation of toxic gases and fires.
- Keep all tubing runs as short as possible.
- Apply refrigerant lubricant to the matching surfaces of the flare and union tubes before connecting them, then tighten the nut with a torque wrench for a leak-free connection.
- Check carefully for leaks before starting the test run.
- Do not leak refrigerant while piping work for an installation or re-installation, and while repairing refrigeration parts.  
Handle liquid refrigerant carefully as it may cause frostbite.
- Under no circumstances shall potential sources of ignition be used in the searching or detection of refrigerant leaks.
- A halide torch (or any other detector using a naked flame) shall not be used.
- Electronic leak detectors may be used to detect refrigerant leaks but, the sensitivity may not be adequate, or may need re-calibration. (Detection equipment shall be calibrated in a refrigerant-free area.)
- Ensure that the detector is not a potential source of ignition and is suitable for the refrigerant used.
- Leak detection equipment shall be set at a percentage of the Lower Flammable Limit (LFL) of the refrigerant and shall be calibrated to the refrigerant employed and the appropriate percentage of gas (25% maximum) is confirmed.
- Leak detection fluids are suitable for use with most refrigerants but the use of detergents containing chlorine shall be avoided as the chlorine may react with the refrigerant and corrode the copper pipe-work.
- If a leak is suspected, all naked flames shall be removed/extinguished.
- If a leakage of refrigerant is found which requires brazing, all of the refrigerant shall be recovered from the system, or isolated (by means of shut off valves) in a part of the system remote from the leak. Oxygen Free Nitrogen (OFN) shall then be purged through the system both before and during the brazing process.
- If refrigerant R32 is used and the optional “R32 refrigerant leakage detection sensor” is connected to the indoor unit, do not turn off the ELCB of the indoor unit except when there is a symptom of abnormality or failure, or when performing short-term maintenance. (When the ELCB is turned off, R32 refrigerant leakage detection sensor cannot detect the refrigerant leakage when the refrigerant leaks, and it may lead to cause the generation of toxic gases and fires.)

## When Servicing

---

- Contact the sales dealer or service dealer for a repair.
- Ventilate the room by opening windows before servicing if there is a possibility of a refrigerant leakage.
- Be sure to turn off the power before servicing.
- Turn the power OFF at the main power box (mains), wait at least 5 minutes until it is discharged, then open the unit to check or repair electrical parts and wiring. 
- Keep your fingers and clothing away from any moving parts.
- Clean up the site after you finish, remembering to check that no metal scraps or bits of wiring have been left inside the unit.

### **WARNING**

- This product must not be modified or disassembled under any circumstances. Modified or disassembled unit may cause fire, electric shock or injury.
- Do not clean inside the indoor and outdoor units by users. Engage authorized dealer or specialist for cleaning.
- In case of malfunction of this appliance, do not repair by yourself. Contact the sales dealer or service dealer for a repair and disposal.

### **CAUTION**

- Ventilate any enclosed areas when installing or testing the refrigeration system. Leaked refrigerant gas, on contact with fire or heat, can produce dangerously toxic gases.
- Confirm after installation that no refrigerant gas is leaking. If the gas comes in contact with a burning stove, gas water heater, electric room heater or other heat source, it can cause the generation of toxic gases and fires.

## Others



---

When disposing of the product, do follow the precautions referring to Section “Recovery” in the installation instructions supplied with the outdoor unit and comply with national regulations.

### **WARNING**

- Do not sit or step on the unit. You may fall down accidentally. 

### **CAUTION**

- Do not touch the air inlet or the sharp aluminum fins of the outdoor unit. You may get injured. 
- Do not stick any object into the FAN CASE. You may be injured and the unit may be damaged. 
- Do not touch the fan because it automatically rotates when it detects a refrigerant leak. You may be injured. 

## SERVICING

### CAUTION

- Any qualified person who is involved with working on or breaking into a refrigerant circuit should hold a current valid certificate from an industry-accredited assessment authority, which authorizes their competence to handle refrigerants safely in accordance with an industry recognised assessment specification.
  - Servicing shall only be performed as recommended by the equipment manufacturer. Maintenance and repair requiring the assistance of other skilled personnel shall be carried out under the supervision of the person competent in the use of flammable refrigerants.
  - Servicing shall be performed only as recommended by the manufacturer.
  - Prior to beginning work on systems containing flammable refrigerants, safety checks are necessary to ensure that the risk of ignition is minimised. For repair to the refrigerating system, (2) to (6) shall be completed prior to conducting work on the system.
- (1) Work shall be undertaken under a controlled procedure so as to minimise the risk of a flammable gas or vapour being present while the work is being performed.
  - (2) All maintenance staff and others working in the local area shall be instructed on the nature of work being carried out. Work in confined spaces shall be avoided. The area around the workspace shall be sectioned off. Ensure that the conditions within the area have been made safe by control of flammable material.
  - (3) The area shall be checked with an appropriate refrigerant detector prior to and during work, to ensure the technician is aware of potentially toxic or flammable atmospheres. Ensure that the leak detection equipment being used is suitable for use with all applicable refrigerants, i.e. non-sparking, adequately sealed or intrinsically safe.
  - (4) If any hot work is to be conducted on the refrigerating equipment or any associated parts, appropriate fire extinguishing equipment shall be available to hand. Have a dry powder or CO<sub>2</sub> fire extinguisher adjacent to the charging area.
  - (5) No person carrying out work in relation to a refrigerating system which involves exposing any pipe work shall use any sources of ignition in such a manner that it may lead to the risk of fire or explosion. All possible ignition sources, including cigarette smoking, should be kept sufficiently far away from the site of installation, repairing, removing and disposal, during which refrigerant can possibly be released to the surrounding space. Prior to work taking place, the area around the equipment is to be surveyed to make sure that there are no flammable hazards or ignition risks. "No Smoking" signs shall be displayed.
  - (6) Ensure that the area is in the open or that it is adequately ventilated before breaking into the system or conducting any hot work. A degree of ventilation shall continue during the period that the work is carried out. The ventilation should safely disperse any released refrigerant and preferably expel it externally into the atmosphere.
  - (7) Where electrical components are being changed, they shall be fit for the purpose and to the correct specification. At all times the manufacturer's maintenance and service guidelines shall be followed. If in doubt, consult the manufacturer's technical department for assistance.
    - The actual refrigerant charge is in accordance with the room size within which the refrigerant containing parts are installed.
    - The ventilation machinery and outlets are operating adequately and are not obstructed.

- Marking to the equipment continues to be visible and legible. Markings and signs that are illegible shall be corrected.
  - Refrigerating pipe or components are installed in a position where they are unlikely to be exposed to any substance which may corrode refrigerant containing components, unless the components are constructed of materials which are inherently resistant to being corroded or are suitably protected against being so corroded.
- (8) Repair and maintenance to electrical components shall include initial safety checks and component inspection procedures. If a fault exists that could compromise safety, then no electrical supply shall be connected to the circuit until it is satisfactorily dealt with. If the fault cannot be corrected immediately but it is necessary to continue operation, an adequate temporary solution shall be used. This shall be reported to the owner of the equipment so all parties are advised. Initial safety checks shall include:
- That capacitors are discharged. This shall be done in a safe manner to avoid possibility of sparking.
  - That no live electrical components and wiring are exposed while charging, recovering or purging the system.
  - That there is continuity of earth bonding.
- During repairs to sealed components, all electrical supplies shall be disconnected from the equipment being worked upon prior to any removal of sealed covers, etc.
  - Particular attention shall be paid to the following to ensure that by working on electrical components, the casing is not altered in such a way that the level of protection is affected. This shall include damage to cables, excessive number of connections, terminals not made to original specification, damage to seals, incorrect fitting of glands, etc.
  - Ensure that apparatus is mounted securely.
  - Ensure that seals or sealing materials have not degraded such that they no longer serve the purpose of preventing the ingress of flammable atmospheres.
  - Replacement parts shall be in accordance with the manufacturer's specifications.

**NOTE:**

The use of silicon sealant may inhibit the effectiveness of some types of leak detection equipment. Intrinsically safe components do not have to be isolated prior to working on them.

- Do not apply any permanent inductive or capacitance loads to the circuit without ensuring that this will not exceed the permissible voltage and current permitted for the equipment in use.
- Intrinsically safe components are the only types that can be worked on while live in the presence of a flammable atmosphere.
- The test apparatus shall be at the correct rating.
- Replace components only with parts specified by the manufacturer. Unspecified parts by manufacturer may result ignition of refrigerant in the atmosphere from a leak.

## REMOVAL AND EVACUATION

### CAUTION

- When breaking into the refrigerant circuit to make repairs – or for any other purpose – conventional procedures shall be used. However, it is important that best practice is followed since flammability is a consideration.  
The following procedure shall be adhered to:
  - Remove refrigerant.
  - Purge the circuit with inert gas.
  - Evacuate.
  - Purge again with inert gas.
  - Open the circuit by cutting or brazing.
- The refrigerant charge shall be recovered into the correct recovery cylinders.
- The system shall be “flushed” with Oxygen Free Nitrogen (OFN) to render the unit safe.
- This process may need to be repeated several times.
- Compressed air or oxygen shall not be used for this task.
- Flushing shall be achieved by breaking the vacuum in the system with OFN and continuing to fill until the working pressure is achieved, then venting to atmosphere, and finally pulling down to a vacuum.
- This process shall be repeated until no refrigerant is within the system.
- When the final OFN charge is used, the system shall be vented down to atmospheric pressure to enable work to take place.
- This operation is absolutely vital if brazing operations on the pipe work are to take place.
- Ensure that the outlet for the vacuum pump is not close to any potential ignition sources and there is ventilation available.

## CHARGING PROCEDURES

### NOTE:

Refer to the Installation Instructions attached to the outdoor unit.

## DECOMMISSIONING

### CAUTION

- Before carrying out this procedure, it is essential that the technician is completely familiar with the equipment and all its details.
- It is recommended good practice that all refrigerants are recovered safely.
- Prior to the task being carried out, an oil and refrigerant sample shall be taken in case analysis is required prior to re-use of recovered refrigerant.
- It is essential that electrical power is available before the task is commenced.
  - a) Become familiar with the equipment and its operation.
  - b) Isolate system electrically.
  - c) Before attempting the procedure ensure that:
    - Mechanical handling equipment is available, if required, for handling refrigerant cylinders.
    - All personal protective equipment is available and being used correctly.



- The recovery process is supervised at all times by a competent person.
- Recovery equipment and cylinders conform to the appropriate standards.
- d) Pump down refrigerant system, if possible.
- e) If a vacuum is not possible, make a manifold so that refrigerant can be removed from various parts of the system.
- f) Make sure that cylinder is situated on the scales before recovery takes place.
- g) Start the recovery machine and operate in accordance with instructions.
- h) Do not overfill cylinders. (No more than 80% volume liquid charge).
- i) Do not exceed the maximum working pressure of the cylinder, even temporarily.
- j) When the cylinders have been filled correctly and the process completed, make sure that the cylinders and the equipment are removed from site promptly and all isolation valves on the equipment are closed off.
- k) Recovered refrigerant shall not be charged into another refrigerating system unless it has been cleaned and checked.
- Electrostatic charge may accumulate and create a hazardous condition when charging or discharging the refrigerant.  
To avoid fire or explosion, dissipate static electricity during transfer by grounding and bonding containers and equipment before charging / discharging.

## **RECOVERY**

### **NOTE:**

Refer to the Installation Instructions attached to the outdoor unit.

### **NOTICE**

The English text is the original instructions. Other languages are translations of the original instructions.

## Check of Density Limit

Check the amount of refrigerant in the system and floor space of the room according to the legislation on refrigerant drainage. If there is no applicable legislation, follow the standards described below.

The refrigerant (R32), which is used in the air conditioner, is a flammable refrigerant. So the requirements for the maximum refrigerant charge amount  $[m_{max}]$  used in the appliance are determined according to installation space of the appliance.

Installation conditions

Procedure of preliminary calculation

1. Determine the room space in accordance with the requirements of installation.
2. Calculate the maximum refrigerant charge amount  $[m_{max}]$ .

When connecting the refrigerant tubes and installing the indoor unit in each partitioned room, it is necessary to calculate the allowable refrigerant charge amount in each room.

For all indoor units shown in Fig. 1, calculate the allowable refrigerant charge amount that can be used in each room  $[m_{IN_1}, m_{IN_2}, \dots, m_{IN_n}]$ .

Calculate the maximum refrigerant charge for each indoor unit from Fig. 2 by referring to the following items.

- Floor area of the room
- Indoor units type
- Capacity of indoor unit
- Installation height of Indoor Unit
- Use or nonuse of R32 refrigerant leakage detection sensor

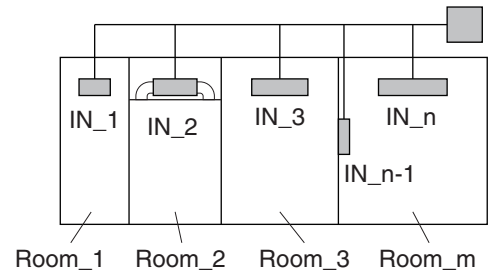

Fig. 1

Room No.	No. of indoor units	Indoor units type	Capacity of indoor unit	Installation height of Indoor Unit: $h_{inst}$ (m)	R32 refrigerant leakage detection sensor	Floor area of the room ( $m^2$ )	Refrigerant charge amount that can be used for each indoor unit (kg)
Room_1	IN_1	4-Way Cassette 60 × 60	15	$h_{inst} \geq 2.2$	Use	10	$m_{IN_1}$
Room_2	IN_2	Slim Low Static Ducted	56	$h_{inst} \geq 2.2$	Nonuse	15	$m_{IN_2}$
Room_3	IN_3	4-Way Cassette	56	$h_{inst} \geq 2.2$	Use	20	$m_{IN_3}$
---	---	---	---	---	---	---	---
Room_m	IN_n-1	Wall-Mounted	45	$h_{inst} \geq 1.8$	Nonuse	30	$m_{IN_n-1}$
Room_m	IN_n	4-Way Cassette	140	$h_{inst} \geq 2.2$	Use	30	$m_{IN_n}$

$$[m_{max}] = \text{Min} (m_{IN_1}, m_{IN_2}, m_{IN_3}, \dots, m_{IN_n-1}, m_{IN_n})$$

The minimum value of the allowable refrigerant charge amount in each room is the maximum value of the maximum refrigerant charge amount  $[m_{max}]$  that can be used in the system.

3. Calculate the maximum refrigerant charge amount  $[m_c]$  by following details of piping installation.

As a reference, refer to Installation Instructions of outdoor unit.

4. Determine from two values  $[m_{max}]$  in Step 2 and  $[m_c]$  in Step 3.

$[m_c] \leq [m_{max}]$  : Can be installed.

$[m_c] > [m_{max}]$  : Return to Steps 1 to 3 and change the indoor unit type, capacity and pipe length.

< Whether or not to use R32 refrigerant leakage detection sensor >

- According to the type of diagrams shown in Fig. 2, it is necessary to install R32 refrigerant leakage detection sensor if the installation space is within the range of using R32 refrigerant leakage detection sensor.
- As to installation method of R32 refrigerant leakage detection sensor, refer to the Installation Instructions attached to the indoor unit and R32 refrigerant leakage detection sensor.
- When connecting R32 refrigerant leakage detection sensor, group connection with a remote controller is not possible. Be sure to prepare a remote controller for each indoor unit.

**NOTE**

In the case of connecting R32 refrigerant leakage detection sensor :

- For systems using R32 refrigerant, this unit is equipped with a refrigerant leak detector for safety. To be effective, the unit must be electrically powered at all times after installation, other than when servicing.

The refrigerant charge amount compared with the floor area of the room is roughly as follows:

Fig. 2

4-Way Cassette 60 × 60

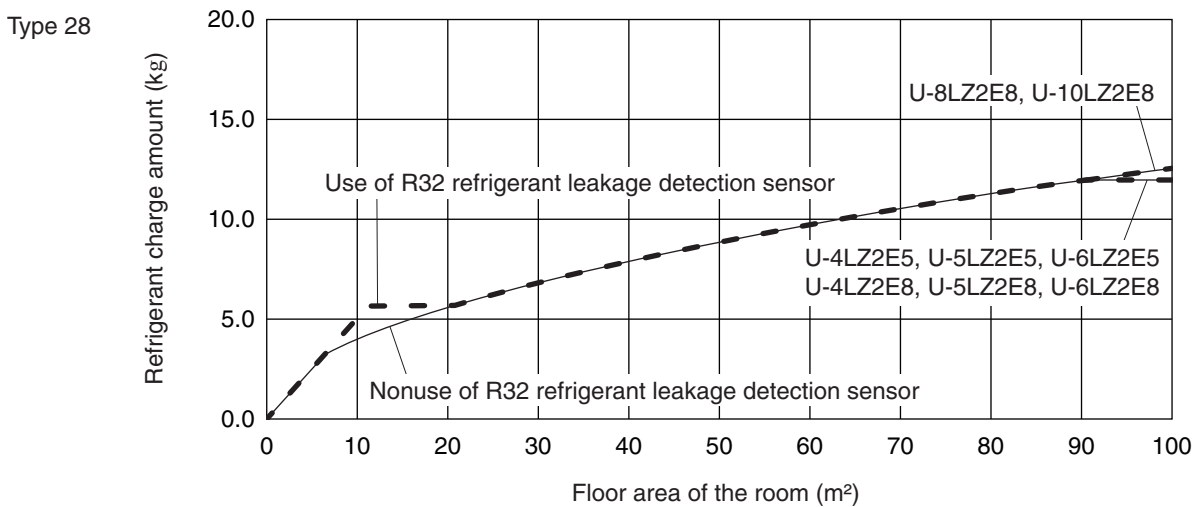
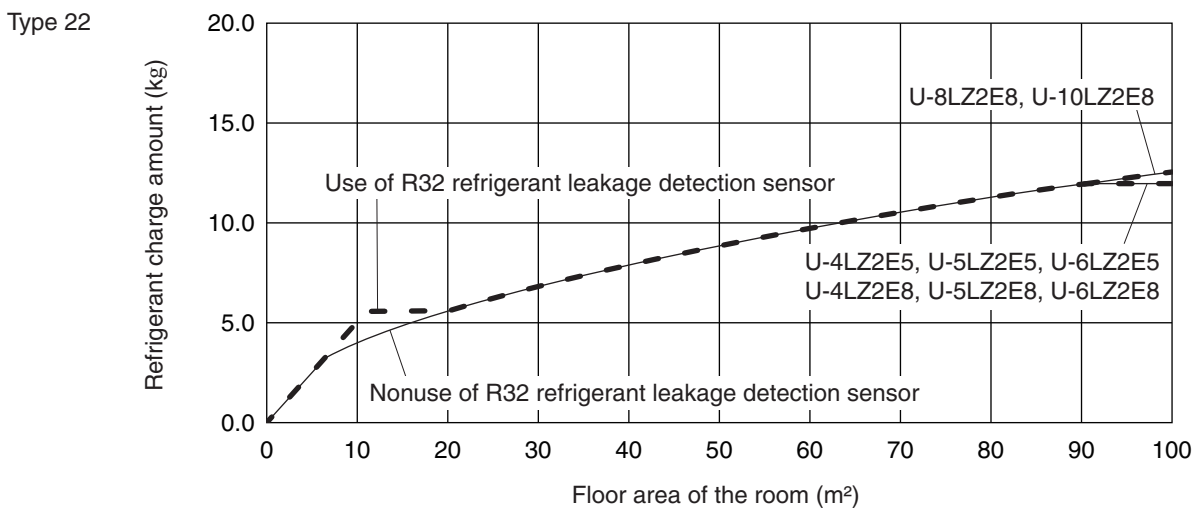
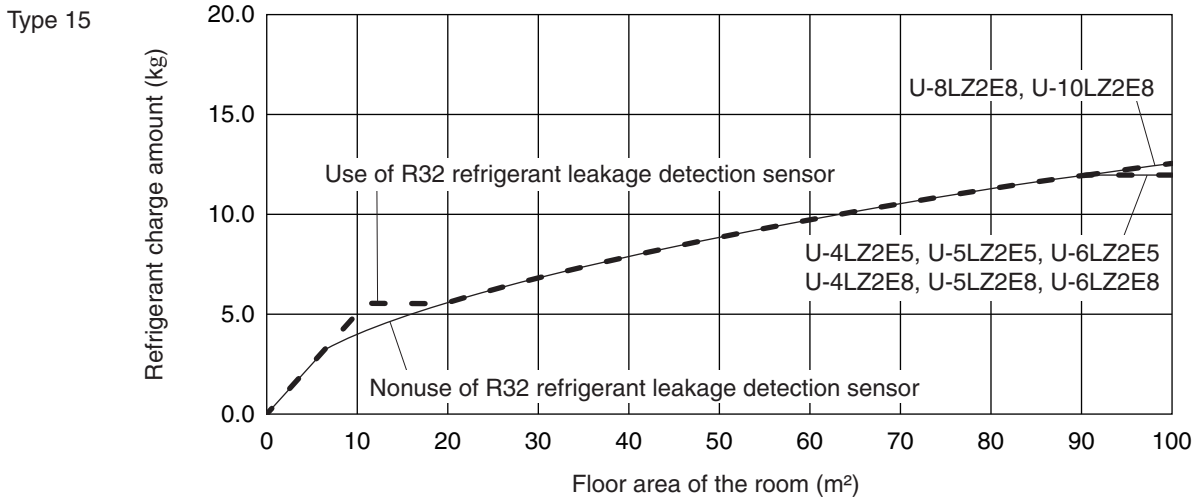

Type 36

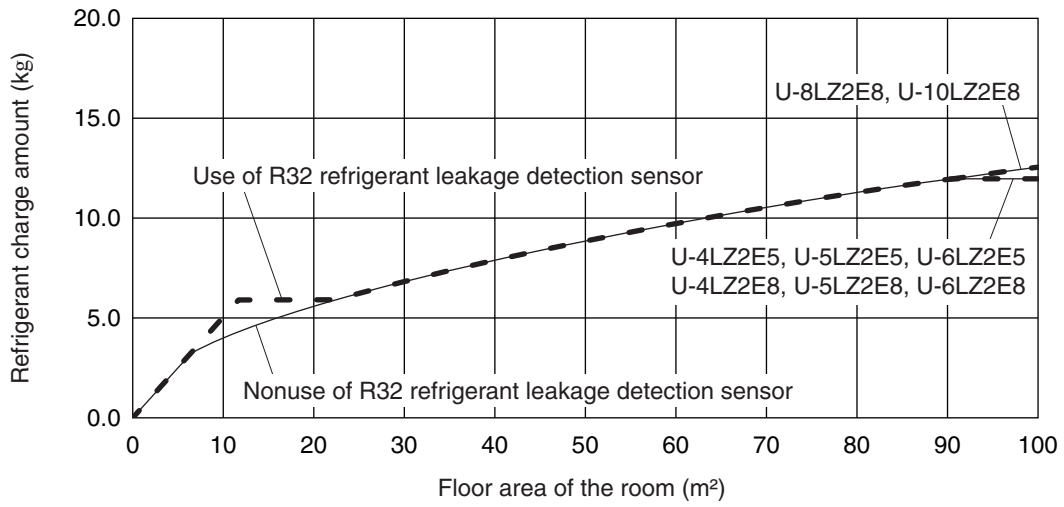

Type 45

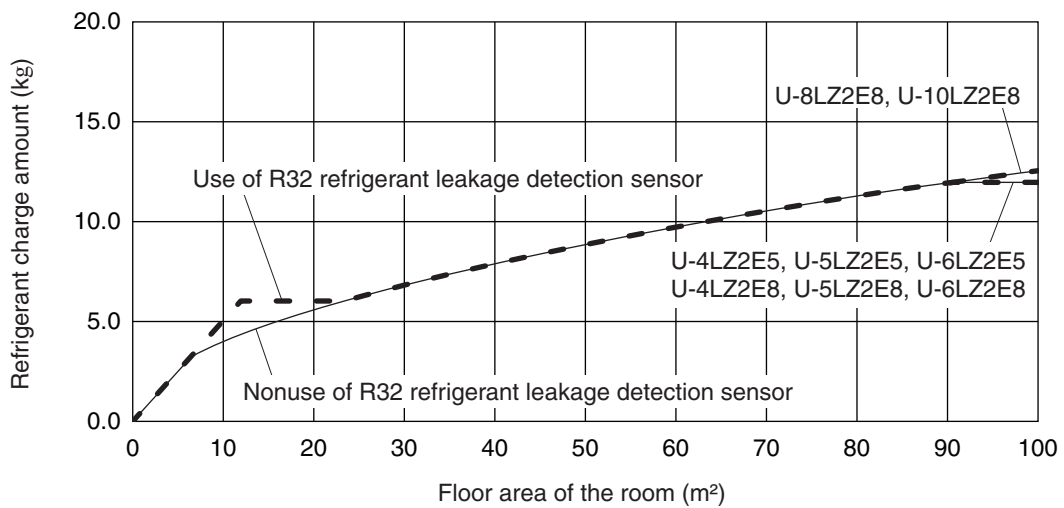

Type 56

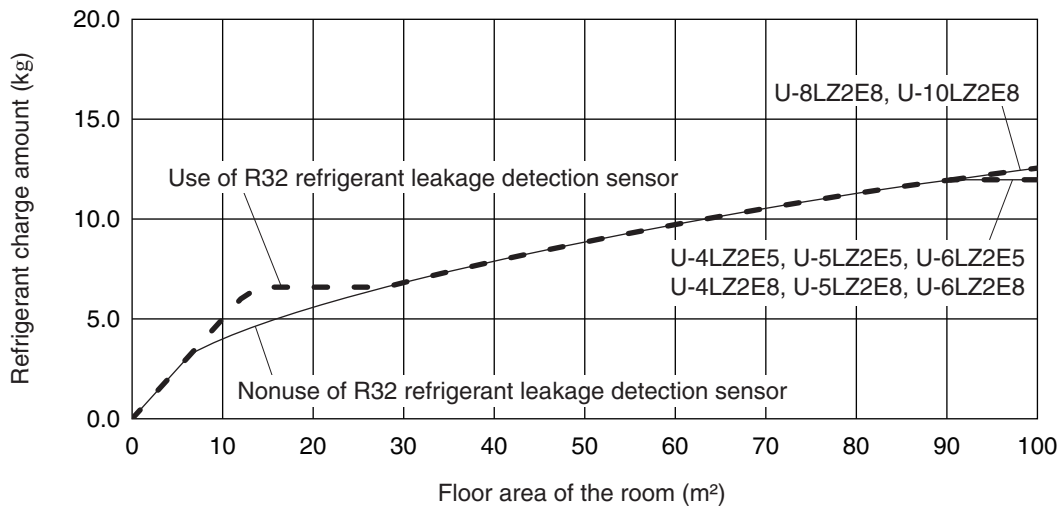

### 4-Way Cassette 60 × 60

	Use or nonuse of R32 refrigerant leakage detection sensor	Nonuse	Use					
	Capacity of indoor unit	15~56	15	22	28	36	45	56
		Refrigerant charge amount (kg)						
Floor area of the room (m <sup>2</sup> )	0	0.0	0.0	0.0	0.0	0.0	0.0	0.0
	2	1.0	1.0	1.0	1.0	1.0	1.0	1.0
	4	2.0	2.0	2.0	2.0	2.0	2.0	2.0
	6	3.0	3.0	3.0	3.0	3.0	3.0	3.0
	8	3.5	4.0	4.0	4.0	4.0	4.0	4.0
	10	3.9	5.0	5.0	5.0	5.0	5.0	5.0
	12	4.3	5.5	5.6	5.7	5.8	6.0	6.0
	14	4.7	5.5	5.6	5.7	5.8	6.0	6.6
	16	5.0	5.5	5.6	5.7	5.8	6.0	6.6
	18	5.3	5.5	5.6	5.7	5.8	6.0	6.6
	20	5.6	5.6	5.6	5.7	5.8	6.0	6.6
	22	5.8	5.8	5.8	5.8	5.8	6.0	6.6
	24	6.1	6.1	6.1	6.1	6.1	6.1	6.6
	26	6.4	6.4	6.4	6.4	6.4	6.4	6.6
	28	6.6	6.6	6.6	6.6	6.6	6.6	6.6
	30	6.8	6.8	6.8	6.8	6.8	6.8	6.8
	32	7.1	7.1	7.1	7.1	7.1	7.1	7.1
	34	7.3	7.3	7.3	7.3	7.3	7.3	7.3
	36	7.5	7.5	7.5	7.5	7.5	7.5	7.5
	38	7.7	7.7	7.7	7.7	7.7	7.7	7.7
	40	7.9	7.9	7.9	7.9	7.9	7.9	7.9
	42	8.1	8.1	8.1	8.1	8.1	8.1	8.1
	44	8.3	8.3	8.3	8.3	8.3	8.3	8.3
	46	8.5	8.5	8.5	8.5	8.5	8.5	8.5
	48	8.7	8.7	8.7	8.7	8.7	8.7	8.7
	50	8.8	8.8	8.8	8.8	8.8	8.8	8.8
	52	9.0	9.0	9.0	9.0	9.0	9.0	9.0
	54	9.2	9.2	9.2	9.2	9.2	9.2	9.2
	56	9.4	9.4	9.4	9.4	9.4	9.4	9.4
	58	9.5	9.5	9.5	9.5	9.5	9.5	9.5
	60	9.7	9.7	9.7	9.7	9.7	9.7	9.7
	62	9.8	9.8	9.8	9.8	9.8	9.8	9.8
64	10.0	10.0	10.0	10.0	10.0	10.0	10.0	
66	10.2	10.2	10.2	10.2	10.2	10.2	10.2	
68	10.3	10.3	10.3	10.3	10.3	10.3	10.3	
70	10.5	10.5	10.5	10.5	10.5	10.5	10.5	
72	10.6	10.6	10.6	10.6	10.6	10.6	10.6	
74	10.8	10.8	10.8	10.8	10.8	10.8	10.8	
76	10.9	10.9	10.9	10.9	10.9	10.9	10.9	
78	11.1	11.1	11.1	11.1	11.1	11.1	11.1	
80	11.2	11.2	11.2	11.2	11.2	11.2	11.2	

4-Way Cassette 60 × 60								
	Use or nonuse of R32 refrigerant leakage detection sensor	Nonuse	Use					
	Capacity of indoor unit	15~56	15	22	28	36	45	56
		Refrigerant charge amount (kg)						
Floor area of the room (m <sup>2</sup> )	82	11.3	11.3	11.3	11.3	11.3	11.3	11.3
	84	11.5	11.5	11.5	11.5	11.5	11.5	11.5
	86	11.6	11.6	11.6	11.6	11.6	11.6	11.6
	88	11.7	11.7	11.7	11.7	11.7	11.7	11.7
	90	11.9	11.9	11.9	11.9	11.9	11.9	11.9
	92	12.0	12.0	12.0	12.0	12.0	12.0	12.0
	94	12.1 (12.0)	12.1 (12.0)	12.1 (12.0)	12.1 (12.0)	12.1 (12.0)	12.1 (12.0)	12.1 (12.0)
	96	12.3 (12.0)	12.3 (12.0)	12.3 (12.0)	12.3 (12.0)	12.3 (12.0)	12.3 (12.0)	12.3 (12.0)
	98	12.4 (12.0)	12.4 (12.0)	12.4 (12.0)	12.4 (12.0)	12.4 (12.0)	12.4 (12.0)	12.4 (12.0)
	100	12.5 (12.0)	12.5 (12.0)	12.5 (12.0)	12.5 (12.0)	12.5 (12.0)	12.5 (12.0)	12.5 (12.0)

( ) : U-4LZ2E5, U-5LZ2E5, U-6LZ2E5, U-4LZ2E8, U-5LZ2E8, U-6LZ2E8

# CONTENTS





	Page		Page
<b>IMPORTANT</b> .....	<b>2</b>	<b>7. HOW TO INSTALL THE PANEL FOR CASSETTE</b> .....	<b>43</b>
Please Read Before Starting		7-1. Preparation for Panel for Cassette Installation	
Check of Density Limit		7-2. How to Install the Panel for Cassette	
<b>1. GENERAL</b> .....	<b>17</b>	7-3. Others	
1-1. Tools Required for Installation (not supplied)		<b>8. HOW TO INSTALL WIRELESS REMOTE CONTROLLER</b> .....	<b>50</b>
1-2. Accessories Supplied with Unit		<b>NOTE</b>	
1-3. Type of Copper Tube and Insulation Material		Refer to the Installation Instructions attached to the optional Wireless Remote Controller.	
1-4. Additional Materials Required for Installation		<b>9. PRECAUTIONS ON TEST RUN</b> .....	<b>51</b>
<b>2. SELECTING THE INSTALLATION SITE</b> .....	<b>19</b>	<b>10. CHECKLIST AFTER INSTALLATION WORK</b> .....	<b>52</b>
2-1. Indoor Unit		<b>11. APPENDIX</b> .....	<b>53</b>
<b>3. HOW TO INSTALL THE INDOOR UNIT</b> .....	<b>22</b>	■ Care and Cleaning	
3-1. Preparation for Suspending		■ Troubleshooting	
3-2. Suspending the Indoor Unit		■ Tips for Energy Saving	
3-3. Placing the Unit Inside the Ceiling		<b>Important Information Regarding The Refrigerant Used</b> .....	<b>57</b>
3-4. How to Process Tubing			
3-5. Installing the Drain Pipe			
3-6. Important Note for Wiring 4-Way Cassette 60 × 60			
<b>4. ELECTRICAL WIRING</b> .....	<b>29</b>		
4-1. General Precautions on Wiring			
4-2. Wire Length and Wire Diameter for Power Supply System			
4-3. Wiring System Diagrams			
<b>5. HOW TO PROCESS TUBING</b> .....	<b>38</b>		
5-1. Connecting the Refrigerant Tubing			
5-2. Connecting Tubing Between Indoor and Outdoor Units			
5-3. Insulating the Refrigerant Tubing			
5-4. Taping the Tubes			
5-5. Finishing the Installation			
<b>6. HOW TO INSTALL THE TIMER REMOTE CONTROLLER OR HIGH-SPEC WIRED REMOTE CONTROLLER (OPTIONAL PART)</b> .....	<b>42</b>		
<b>NOTE</b>			
Refer to the Installation Instructions attached to the optional Timer Remote Controller or optional High-spec Wired Remote Controller.			



# 1. GENERAL

This booklet briefly outlines where and how to install the air conditioning system. Please read over the entire set of instructions for the indoor and outdoor units and make sure all accessory parts listed are with the system before beginning.









The installation of pipe-work shall be kept to a minimum.

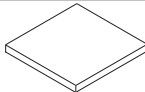

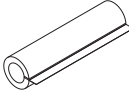
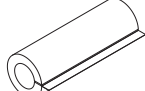
 <b>WARNING</b>	This symbol shows that this equipment uses a flammable refrigerant. If the refrigerant is leaked, together with an external ignition source, there is a possibility of ignition.
 <b>CAUTION</b>	This symbol shows type of flammable refrigerant contained in the system.
 <b>CAUTION</b>	This symbol shows that the Operating Instructions should be read carefully.
 <b>CAUTION</b>	This symbol shows that a service personnel should be handling this equipment with reference to the Technical Manual.
 <b>CAUTION</b>	This symbol shows that there is information included in the Operating Instructions and/or Installation Instructions.

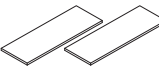
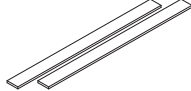
## 1-1. Tools Required for Installation (not supplied)

1. Flathead screwdriver
2. Phillips head screwdriver
3. Knife or wire stripper
4. Tape measure
5. Carpenter's level
6. Sabre saw or keyhole saw
7. Hacksaw
8. Core bits
9. Hammer
10. Drill
11. Tube cutter
12. Tube flaring tool
13. Torque wrench
14. Adjustable wrench
15. Reamer (for deburring)

## 1-2. Accessories Supplied with Unit

Part Name	Figure	Q'ty	Remarks
Full-scale installation diagram		1	Printed on container box
Washer		8	For suspension bolts
Screw		4	For full-scale installation diagram
Flare insulator		1	For liquid tube
Flare insulator		1	For gas tube
Drain hose		1	For main unit + PVC pipe joints
Hose band		1	For securing drain hose
Packing		2	For drain hose joint 70 × 220 (mm)
Packing		2	For gas and liquid tubes flare nuts 30 × 500 (mm)
Drain insulator		1	For drain hose joint
Clamper		2	For drain hose joint
Clamper		2	For electrical wiring

Part Name	Figure	Q'ty	Remarks
Operating Instructions		1	
Installation Instructions		1	

- Use M10 for suspension bolts.
- Field supply for suspension bolts and nuts.

### 1-3. Type of Copper Tube and Insulation Material

If you wish to purchase these materials separately from a local source, you will need:

1. Deoxidized annealed copper tube for refrigerant tubing.
2. Foamed polyethylene insulation for copper tubes as required to precise length of tubing. Wall thickness of the insulation should be not less than 8 mm.
3. Use insulated copper wire for field wiring. Wire size varies with the total length of wiring. See Section "4. ELECTRICAL WIRING" for details.



#### **CAUTION**

**Check local electrical codes and regulations before obtaining wire. Also, check any specified instructions or limitations.**

### 1-4. Additional Materials Required for Installation

1. Refrigeration (armored) tape
2. Insulated staples or clamps for connecting wire (See your local codes.)
3. Putty
4. Refrigeration tubing lubricant
5. Clamps or saddles to secure refrigerant tubing
6. Scale for weighing

## 2. SELECTING THE INSTALLATION SITE

### 2-1. Indoor Unit

#### AVOID:

- areas where leakage of flammable gas may be expected.
- places where large amounts of oil mist exist.
- direct sunlight.
- locations near heat sources which may affect the performance of the unit.
- locations where external air may enter the room directly. This may cause “condensation” on the air discharge ports, causing them to spray or drip water.
- locations where the remote controller will be splashed with water or affected by dampness or humidity.
- installing the remote controller behind curtains or furniture.
- locations where high-frequency emissions are generated.

#### DO:

- select an appropriate position from which every corner of the room can be uniformly cooled.
- select a location where the ceiling is strong enough to support the weight of the unit.

#### WARNING

**The installation position must be able to support a load four times the indoor unit weight.**

- select a location where tubing and drain pipe have the shortest run to the outdoor unit.
- allow room for operation and maintenance as well as unrestricted airflow around the unit.
- the limitation of the tubing length between the indoor and the outdoor units should be referred to the Installation Instructions of the outdoor unit.
- allow room for mounting the remote controller about 1 m off the floor, in an area that is not in direct sunlight or in the flow of cool air from the indoor unit.
- If the inside of the ceiling is high temperature and high humidity, apply the polyethylene foam or other materials of minimum thickness of 10 mm or more to the unit.

#### 4-Way Cassette 60 x 60

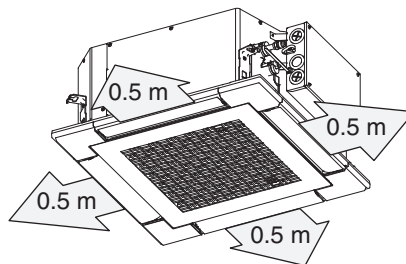

**NOTE**

Air delivery will be degraded if the distance from the floor to the ceiling is greater than 3 m.

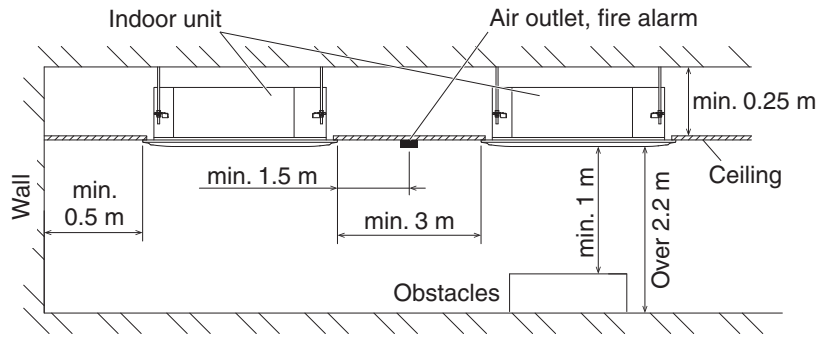

\* If the height from the floor to ceiling exceeds three meters, air flow distribution deteriorates and the effect is decreased.

**Installation location of R32 refrigerant leakage detection sensor**

When installing R32 refrigerant leakage detection sensor away from the indoor unit, place it at 300 mm or less from a floor surface and satisfy the condition either (1) or (2) below.

- (1) If no obstacles exist in a straight line from R32 refrigerant leakage detection sensor to the indoor unit, wall distance should be within 10 m in horizontal straight line.

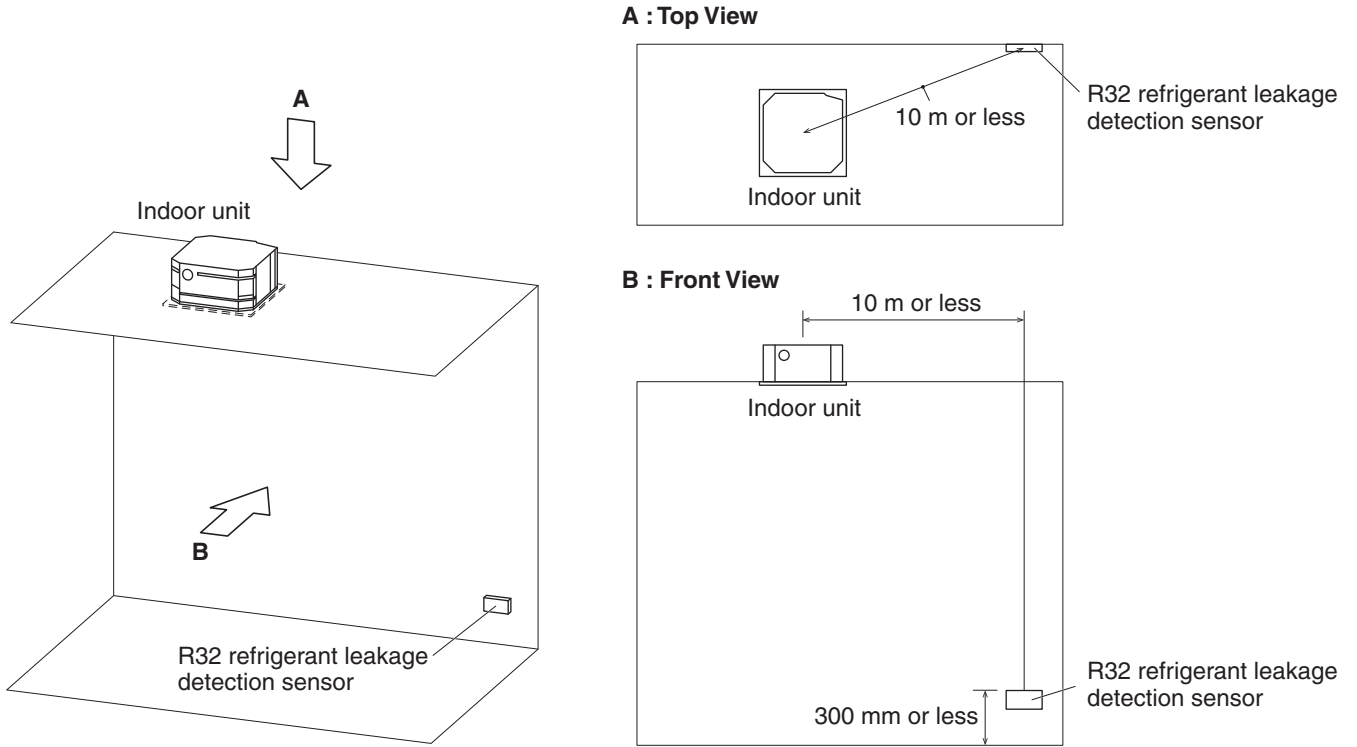

- (2) If obstacles exist in a straight line from R32 refrigerant leakage detection sensor to the indoor unit, wall distance should be within 7 m in horizontal straight line.

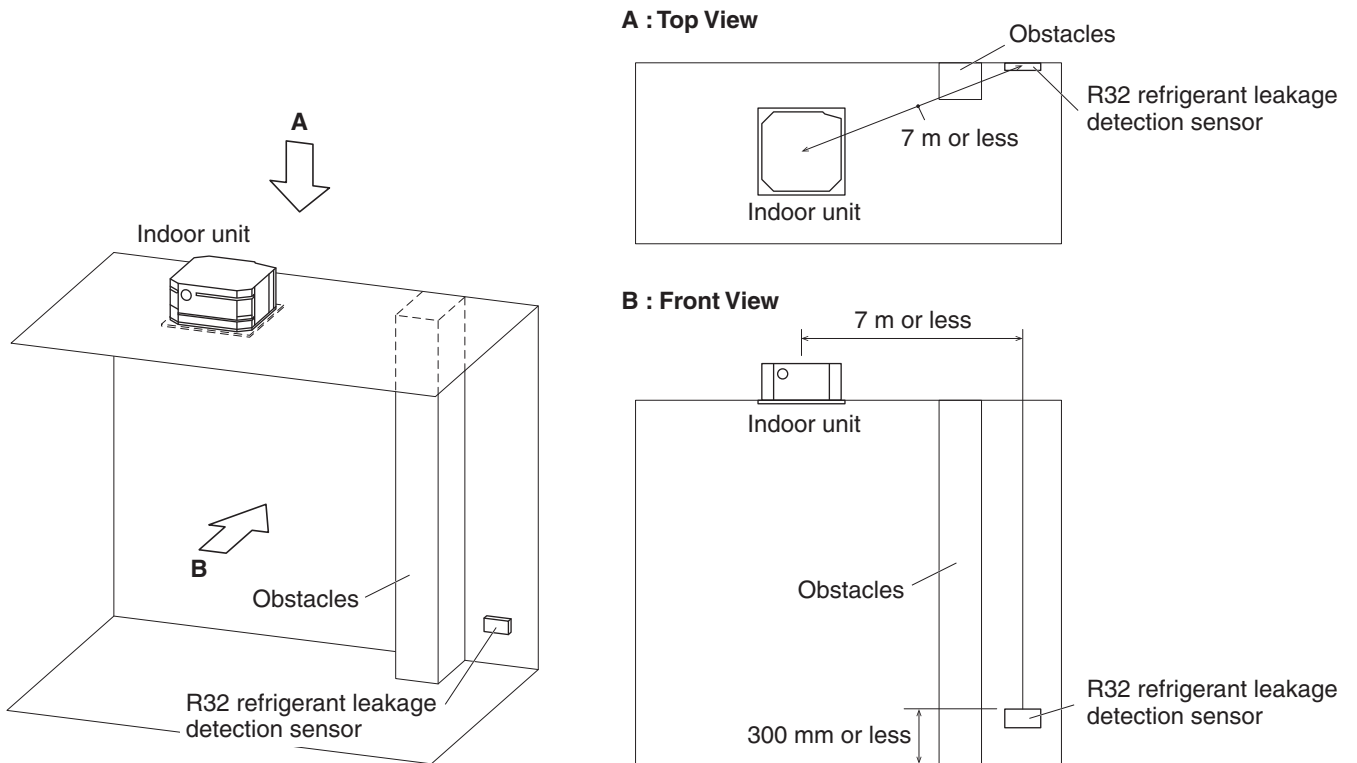

### 3. HOW TO INSTALL THE INDOOR UNIT

#### 3-1. Preparation for Suspending

This unit uses a drain pump. Use a carpenter's level to check that the unit is level.

#### 3-2. Suspending the Indoor Unit

(1) Fix the suspension bolts securely in the ceiling using the method shown in the diagrams, by attaching them to the ceiling support structure, or by any other method that ensures that the unit will be securely and safely suspended.

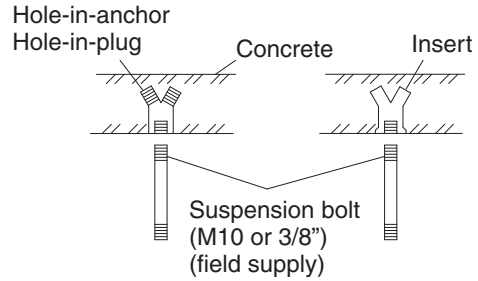

(2) Follow the diagram to make the holes in the ceiling. Install the inspection opening on the electrical component box side where maintenance and inspection of the electrical component box and drain pump are easy.

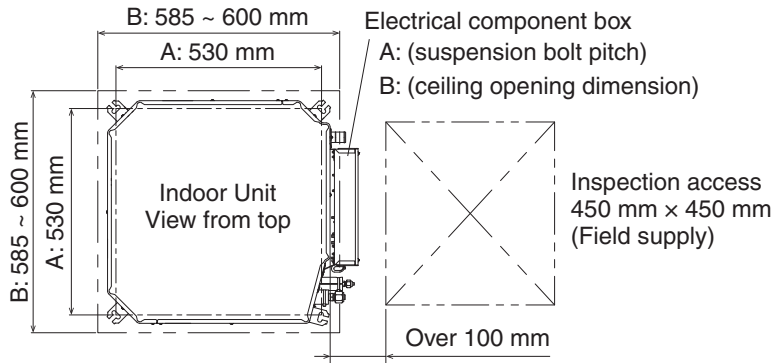

(3) Determine the pitch of the suspension bolts using the supplied full-scale installation diagram (printed on container box).

The diagram show the relationship between the positions of the suspension fitting, unit, and panel.

Use the nut (field supply) and washer (supplied) for upper and lower position of the suspension lug.

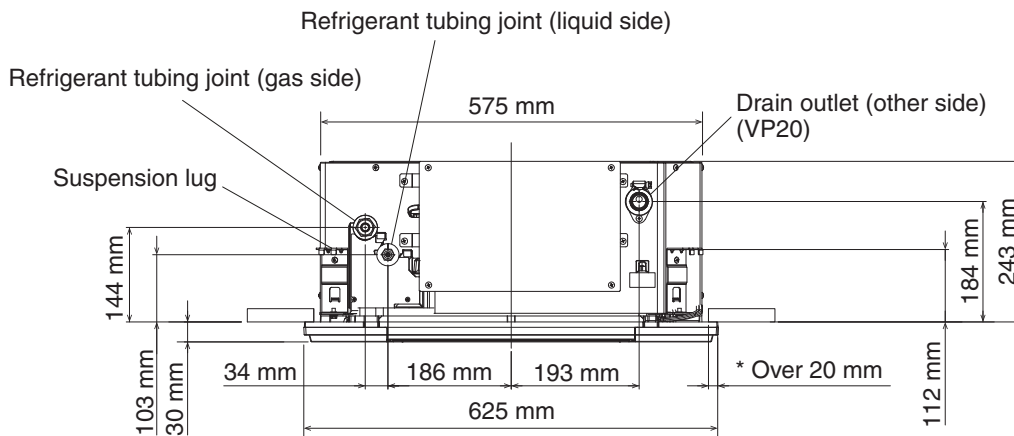

\* The overlapping portion between the ceiling and panel for cassette should be kept over 20 mm.

### 3-3. Placing the Unit Inside the Ceiling

This air conditioner is designed to be installed on the system ceiling.

Care must be taken before installation so that the maintenance or relocation can be done instantly.

This unit is equipped with the drain pump. Check with a tape measure or carpenter's level (less than 1/100).

Water leakage may occur if the unit is not installed horizontally.

Before installing the panel for cassette, complete the work of drain pipe and refrigerant tube installation.

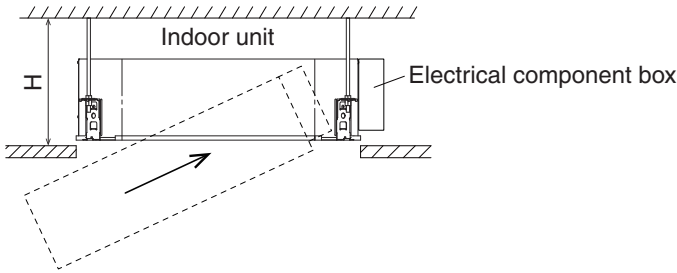

H :

If the roof space is 285 mm or more in height, it is possible to remove the grid system ceiling panel and place the unit inside the system ceiling.

If the roof space is more than 250 mm and less than 285 mm in height, first remove the grid system ceiling panel and T-Bar supporting the system ceiling temporarily, and then place the unit inside the ceiling.

- (1) When placing the unit inside the ceiling, determine the pitch of the suspension bolts using the supplied full-scale installation diagram.

Labeling: (1) When placing the unit inside the ceiling, determine the pitch of the suspension bolts using the supplied full-scale installation diagram. Tubing and wiring must be laid inside the ceiling when suspending the unit. If the ceiling is already constructed, lay the tubing and wiring into position for connection to the unit before placing the unit inside the ceiling.

- (2) The length of suspension bolts must be appropriate for a distance between the bottom of the bolt and the bottom of the unit of more than 18 mm.

If there is a ceiling opening, install the indoor unit's electrical component box side first in the opening portion.

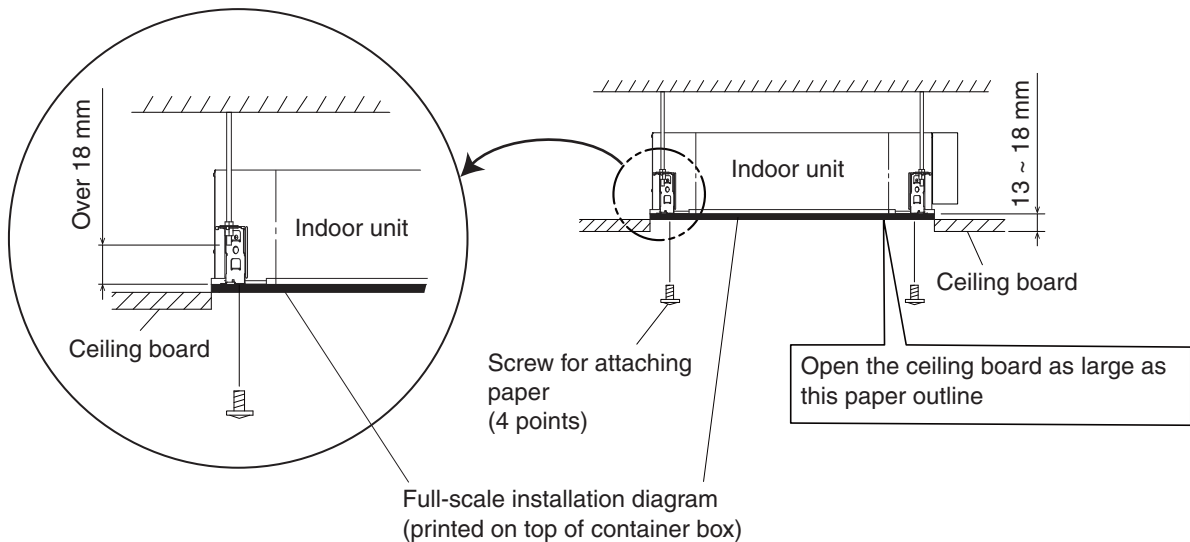

- (3) Thread the 3 hexagonal nuts and 2 washers onto each of the 4 suspension bolts. Use 1 nut and 1 washer for the upper side, and 2 nuts and 1 washer for the lower side, so that the unit will not fall off the suspension lugs.
- (4) Adjust so that the distance between the unit and the ceiling bottom is 13 ~ 18 mm. Tighten the nuts on the upper side and lower side of the suspension lug.
- (5) If the protection tape for the fan during transportation remains, peel off the tape.
- (6) Check with a tape measure or carpenter's level (less than 1/100).

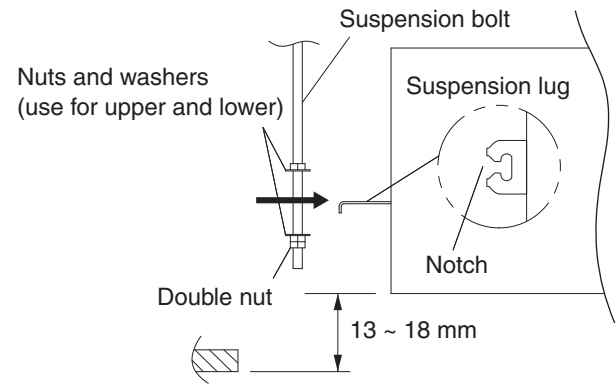

### 3-4. How to Process Tubing

See Section "5. HOW TO PROCESS TUBING".



### 3-5. Installing the Drain Pipe

#### 3-5-1. Before Performing the Installation Drain Piping

##### (1) Limitations of Raising the Drain Pipe Connection

**CAUTION**

- The drain pipe can be raised to a maximum height of 850 mm from the bottom of the ceiling. Do not attempt to raise it higher than 850 mm. Doing so will result in water leakage.

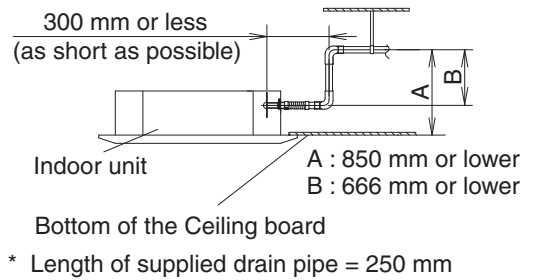

##### (2) Limitations of Drain Pipe Connection

**CAUTION**

- Do not install the drain pipe with an upward gradient from the drain port connection. This will cause the drain water to flow backward and leak when the unit is not operating.
- Do not install an air bleeder as this may cause water to spray from the drain pipe outlet.
- Do not provide U-trap or bell-shaped trap in the middle of the drain pipe. Doing so will cause abnormal sound.
- Make sure the drain pipe has a downward gradient (1/100 or more; downward from drain port connection).

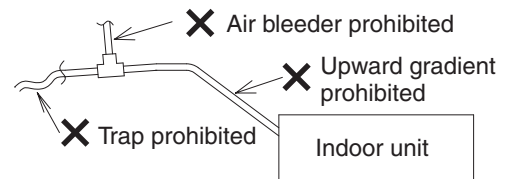

Separation of support bracket = 1.5 ~ 2 m

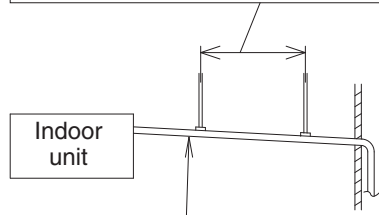

Downward gradient = 1/100 or more

##### (3) Limitations of Drain Hose Connection

**CAUTION**

- Do not bend the supplied drain hose 90° or more. Bend it less than 45°.
- Do not make a trap in the middle of the supplied drain hose. Doing so will cause abnormal sound.

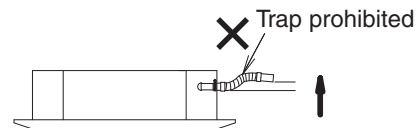
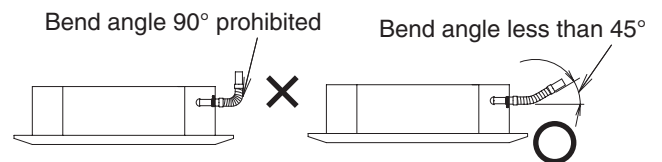

### 3-5-2. Installing the Drain Pipe

#### CAUTION

- Do not apply force to the drain port when connecting the drain pipe. Install and fix it near the indoor unit as close as possible.
- Do not use adhesive when connecting the drain port pipe and the drain hose.

#### (1) How to Install the Drain Pipe

- 1) First insert the supplied hose band into the drain port pipe. Then make sure the head of the screw is facing toward a technical engineer when placing the screw of the hose band at an upward angle.
- 2) Insert the soft PVC socket of the supplied drain hose to the drain port pipe. Do not use adhesive when connecting the drain hose to the drain port pipe. Insert it until the tip of the drain hose contacts the uneven surface of the drain port pipe.
- 3) Move the hose band so that the center position of the hose band can be placed approx. 30 mm away from the external plate of the indoor unit. See diagram below.
- 4) Screw the drain hose tightly facing the screw of the hose band upward. (Torque: 3.0 N·m - 3.5 N·m) (If the screw is tightened beneath the drain hose, the troubles will be generated.)
- 5) Apply approx. 2 g of adhesive on both sides of the drain hose without connection of the hard PVC socket and the hard PVC pipe joint (VP20) in the field supply.
- 6) Connect the drain hose and the hard PVC pipe joint so that the adhesive area of both sides can be overlapped. Wipe off the protrusion-adhesive with a soft cloth.

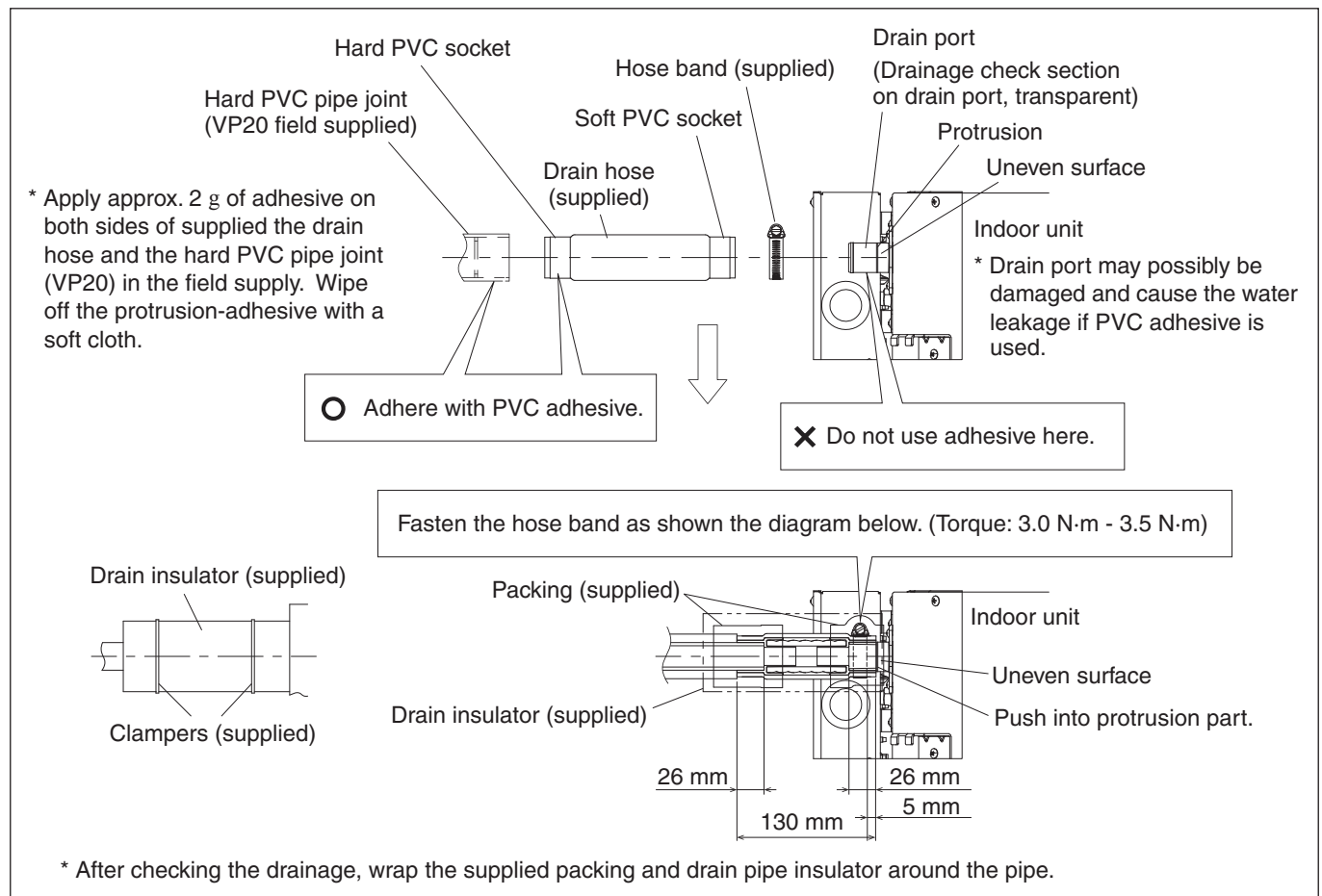

### 3-5-3. Checking the Drainage



**CAUTION** Be careful since the fan will start when you short the pin on the indoor unit control PCB.

After wiring (see Section “4. ELECTRICAL WIRING”.) and drain piping are completed, use the following procedure to check that the water will drain smoothly. For this, prepare a bucket and wiping cloth to catch and wipe up spilled water.

- (1) Connect power to the power terminal board (L/1, N/2 terminals) inside the electrical component box.
- (2) Slowly pour about 1 L of water into the drain pan to check drainage.

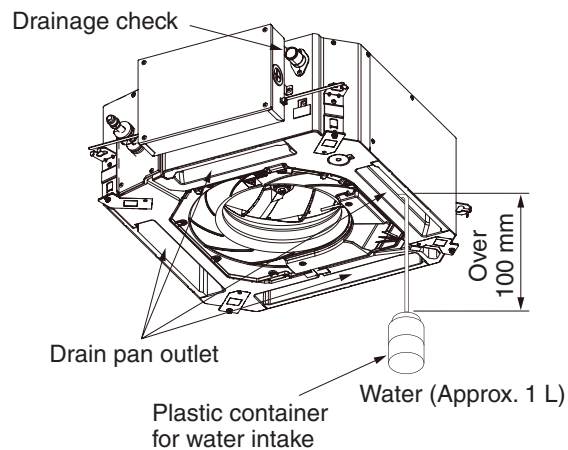

- (3) Short the check pin (CHK) (6P : 1-4) on the indoor unit control PCB and operate the drain pump. Check the water flow through the transparent drain pipe and see if there is any leakage.
  - \* If the check pin (CHK) (6P : 1-4) is shorted, the fan starts rotating at high speed and could cause injury.
- (4) When the check of drainage is complete, open the check pin (CHK) (6P : 1-4) and remount the tube cover.
- (5) Checkpoint after installation  
After installation of indoor and outdoor units, panels and electrical wiring, see Section “10. CHECKLIST AFTER INSTALLATION WORK”.

### 3-6. Important Note for Wiring 4-Way Cassette 60 × 60

- (1) The power supply inlet is located at the lower area of the refrigerant tubing side.  
The electrical component box is located at the refrigerant tubing side.
- (2) Before installing the panel for cassette, be sure to carry out the wiring connection.
- (3) Remove the lid located on the electrical component box by unscrewing the screws (M4 × L6) (×4).
- (4) Lead the wires from the power supply inlet to the unit. Be sure to lead the wires through the power supply inlet. Make sure that no wire is caught between the indoor unit and panel for cassette. Otherwise, the unit may cause a fire.
- (5) Connect the wires into the terminals through the power supply inlet for the electrical component box.  
Fix the wires with a clamping clip.
- (6) Reinstall the lid of the electrical component box in its original position with paying attention not to have the wires caught in the lid.  
See Section “4. ELECTRICAL WIRING”.

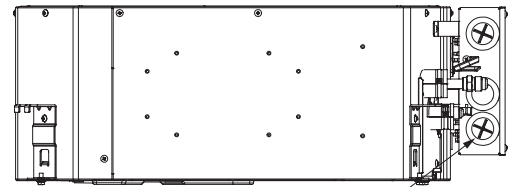

Power supply inlet

Screws (M4 × L6) position

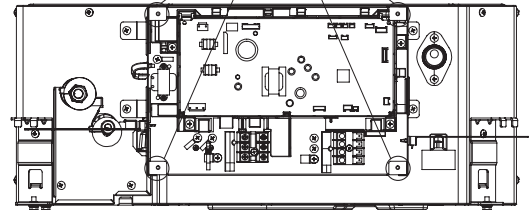

## 4. ELECTRICAL WIRING

### 4-1. General Precautions on Wiring

- (1) Before wiring, confirm the rated voltage of the unit as shown on its nameplate, then carry out the wiring closely following the wiring diagram under Section 4-3.



#### **WARNING**

- (2) This equipment is strongly recommended to be installed with Earth Leakage Circuit Breaker (ELCB) or Residual Current Device (RCD). Otherwise, it may cause electrical shock and fire in case of equipment breakdown or insulation breakdown.  
The ELCB must be incorporated in the fixed wiring in accordance with the wiring regulations. The ELCB must be an approved circuit capacity, having a contact separation in all poles.  
The ELCB or RCD suitable for use with inverters, resistant to high frequency noise, is most suitable. The ELCB's or RCD's intended for protection to include high frequency currents are unnecessary and should be avoided, as potentially causing nuisance tripping, in this application.
- (3) To prevent possible hazards from insulation failure, the unit must be grounded.
- (4) Each wiring connection must be done in accordance with the wiring system diagram. Wrong wiring may cause the unit to misoperate or become damaged.
- (5) Do not allow wiring to touch the refrigerant tubing, compressor, or any moving parts of the fan.
- (6) Unauthorized changes in the internal wiring can be very dangerous. The manufacturer will accept no responsibility for any damage or misoperation that occurs as a result of such unauthorized changes.
- (7) Regulations on wire diameters differ from locality to locality. For field wiring rules, please refer to your LOCAL ELECTRICAL CODES before beginning.  
You must ensure that installation complies with all relevant rules and regulations.
- (8) To prevent malfunction of the air conditioner caused by electrical noise, care must be taken when wiring as follows:
  - The remote control wiring and the inter-unit control wiring should be wired apart from the inter-unit power wiring.
  - Use shielded wires for inter-unit control wiring between units and ground the shield on both sides.



#### **CAUTION**

**Check local electrical codes and regulations before wiring. Also, check any specified instruction or limitations.**

## 4-2. Wire Length and Wire Diameter for Power Supply System

### Indoor unit

Type	(B) Power supply cable	Time delay fuse or circuit capacity
	Min. 2.5 mm <sup>2</sup> *1	
Y3	Max. 130 m*2	15 A

### Control wiring

(C) Inter-unit (between outdoor and indoor units) control wiring	(D) Remote control wiring	(E) Remote control wiring for group control
Min. 0.75 mm <sup>2</sup> Use shielded wiring*3	Min. 0.75 mm <sup>2</sup>	Min. 0.75 mm <sup>2</sup>
Max. 1,000 m	Max. 500 m	Max. 200 m (Total)

#### NOTE

\*1 Maximum applicable wire for terminal board of indoor unit : 4 mm<sup>2</sup>

\*2 Maximum length shows a 2% voltage drop.

\*3 With ring-type wire terminal

### 4-3. Wiring System Diagrams

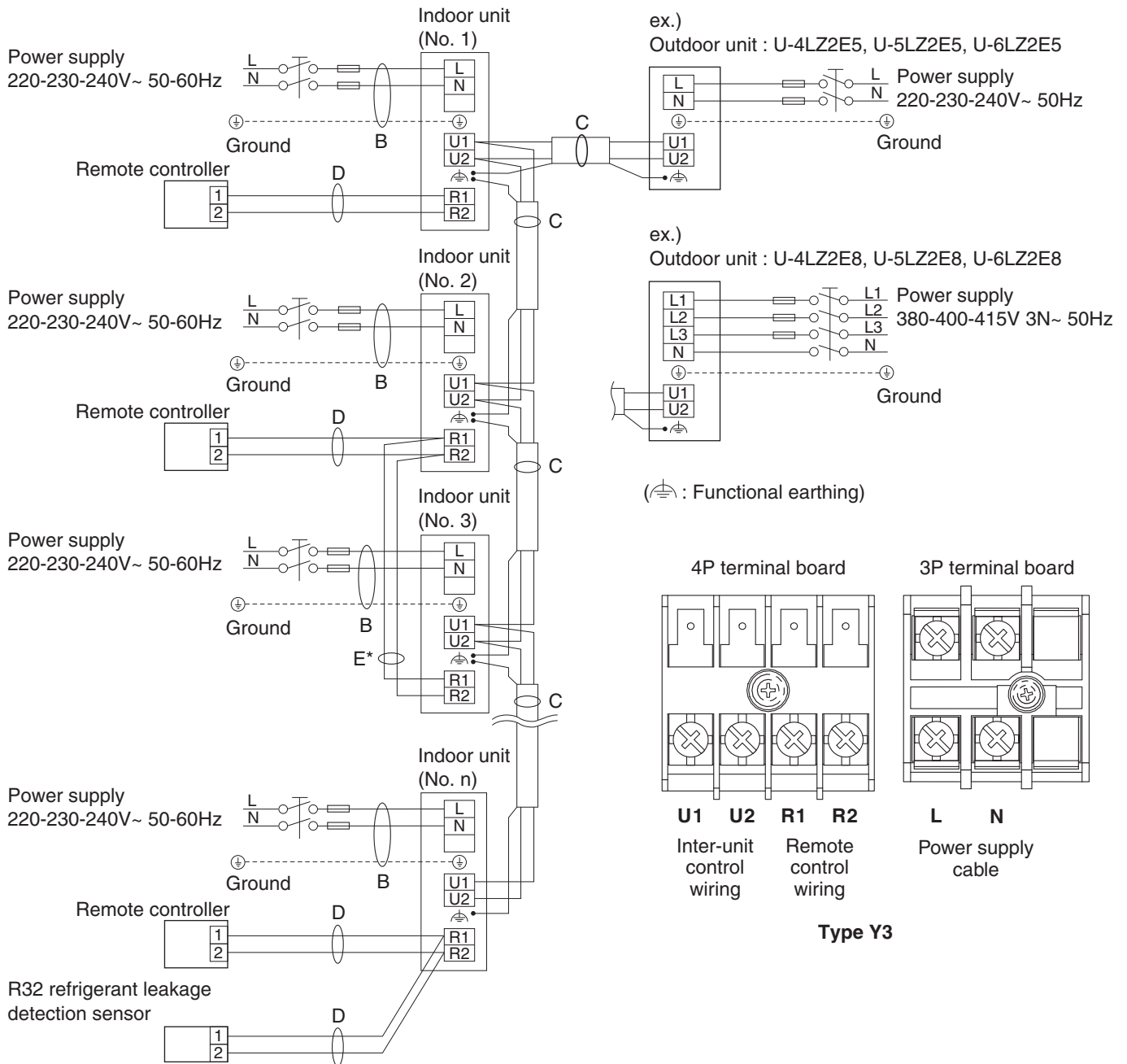

**NOTE**

- (1) See Section 4-2 for the explanation of “B”, “C”, “D” and “E” under Section 4-3.
  - (2) The basic connection diagram of the indoor unit shows the terminal boards, so the terminal boards in your equipment may differ from the diagram.
  - (3) Refrigerant Circuit address should be set before turning the power on.
  - (4) Regarding Refrigerant Circuit address setting, refer to the installation instructions supplied with the remote controller (Optional). Auto address setting can be executed by remote controller automatically.
  - (5) In the case of connecting R32 refrigerant leakage detection sensor :
    - Be sure to make wirings through the ceiling or the walls so that the wires of R32 refrigerant leakage detection sensor cannot be visible from inside the room.
    - A single R32 refrigerant leakage detection sensor cannot be connected to multiple indoor units.
- \* Group connection “E” with a remote controller is not possible. Be sure to connect a remote controller to each indoor unit.

**CAUTION**

- (1) When linking the outdoor units in a network, disconnect the terminal extended from the short plug from all outdoor units except any one of the outdoor units.  
(When shipping: In shorted condition.)  
For a system without link (no wiring connection between outdoor units), do not remove the short plug.

- (2) Do not install the inter-unit control wiring in a way that forms a loop.

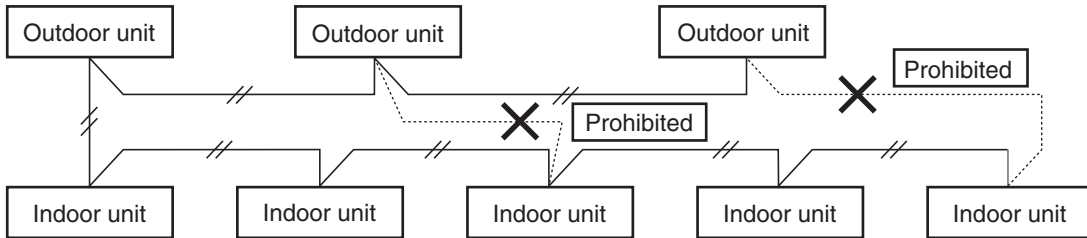

- (3) Do not install inter-unit control wiring such as star branch wiring. Star branch wiring causes mis-address setting.

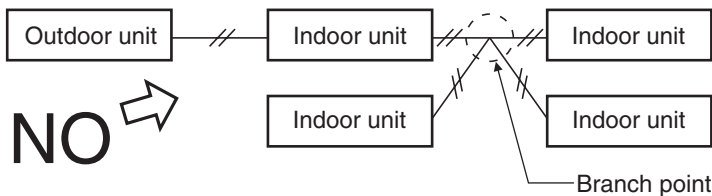

- (4) If branching the inter-unit control wiring, the number of branch points should be 16 or fewer.

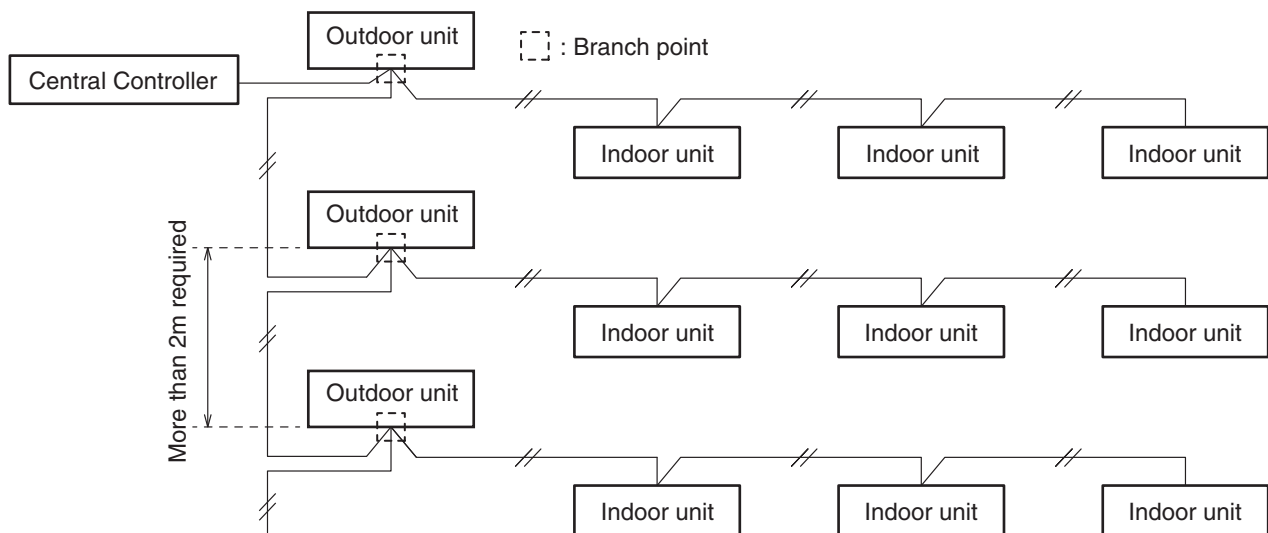

- (5) Use shielded wires for inter-unit control wiring (C) and ground the shield on both sides, otherwise misoperation from noise may occur. Connect wiring as shown in Section 4-3.

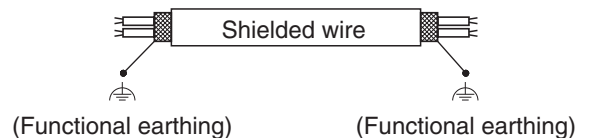

- (6) Use the standard power supply cables for Europe (such as H05RN-F or H07RN-F which conform to CENELEC (HAR) rating specifications) or use the cables based on IEC standard. (60245 IEC57, 60245 IEC66)



**! WARNING**

**Loose wiring may cause the terminal to overheat or result in unit malfunction. A fire hazard may also occur. Therefore, ensure that all wiring is tightly connected.**

When connecting each power wire to the terminal, follow the instructions on “How to connect wiring to the terminal” and fasten the wire securely with the terminal screw.

**How to connect wiring to the terminal**

**■ For stranded wiring**

- (1) Cut the wire end with cutting pliers, then strip the insulation to expose the stranded wiring about 10 mm and tightly twist the wire ends. Then attach the ring pressure terminal.
- (2) Using a Phillips head screwdriver, remove the terminal screw(s) on the terminal board.
- (3) Using a ring connector fastener or pliers, securely clamp each stripped wire end with a ring pressure terminal.
- (4) Place the ring pressure terminal, and replace and tighten the removed terminal screw using a screwdriver.

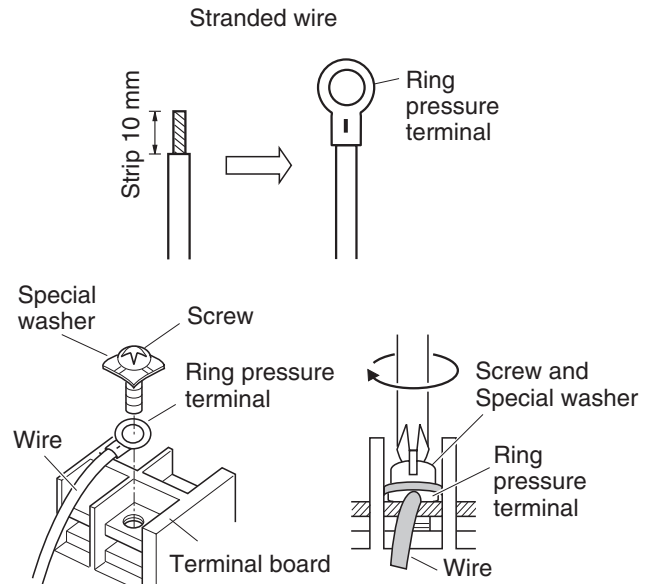

**■ Examples of shield wires**

- (1) Remove cable coat not to scratch braided shield.
- (2) Unbraid the braided shield carefully and twist the unbraided shield wires tightly together. Insulate the shield wires by covering them with an insulation tube or wrapping insulating tape around them.
- (3) Remove coat of signal wire.
- (4) Attach ring pressure terminals to the signal wires and the shield wires insulated in Step (2).

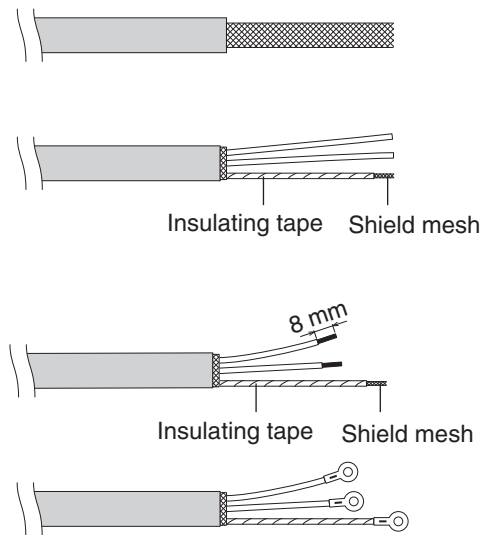

## ■ Wiring samples

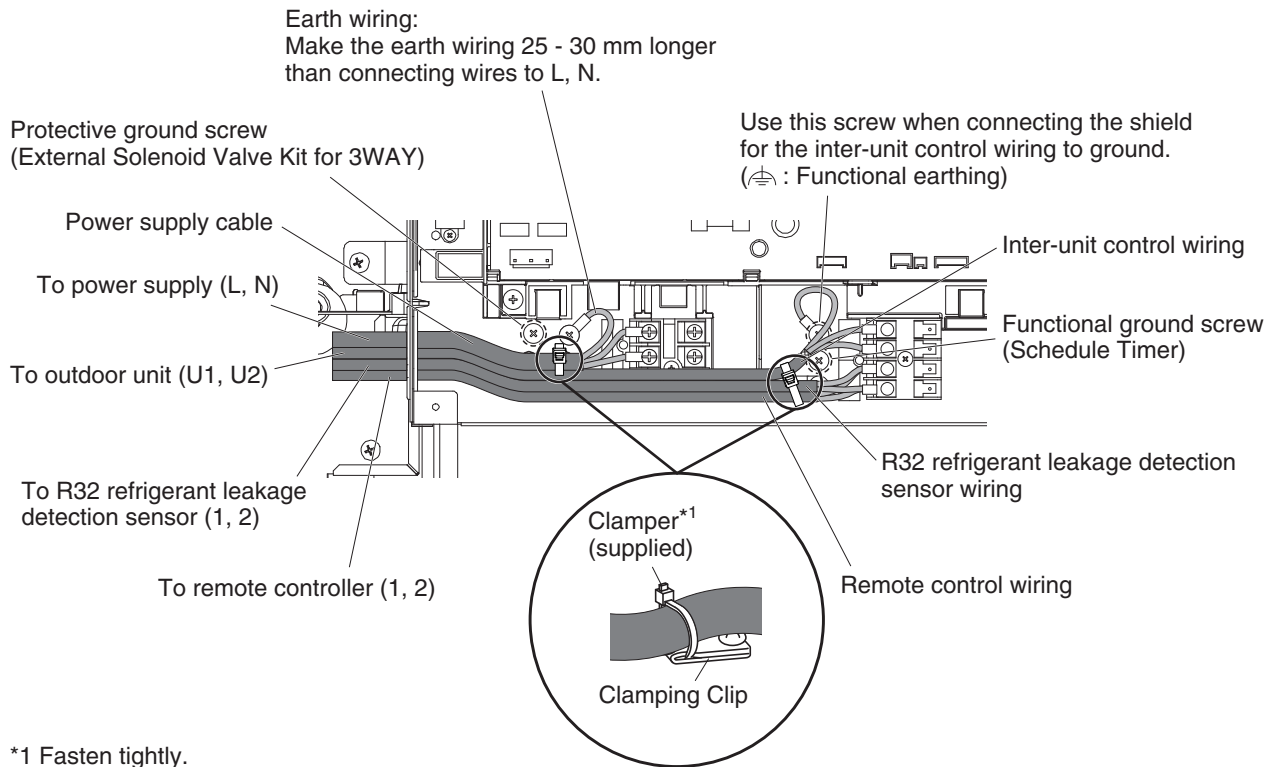

\*1 Fasten tightly.

## ■ When connecting with 3WAY VRF outdoor unit

### < In the case of Solenoid Valve Kit (CZ-P56HR3, CZ-P160HR3) + Solenoid Valve Controller (CZ-CAPE2) >

Read the Installation Instructions of Solenoid Valve Controller before installation.

1. Install the Solenoid Valve Controller as shown below.

NOTE 1: When connecting to the grid system ceiling, install the Solenoid Valve Controller (CZ-CAPE2) after installation of the indoor unit in the ceiling.  
In respect of the ceiling other than the grid system, install it near the inspection hole.

NOTE 2: Be aware that the Solenoid Valve Controller should be installed in the direction as shown in figure below.

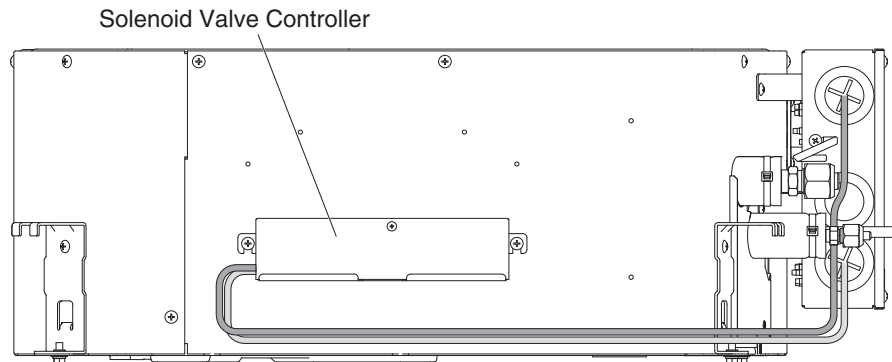

2. Make wiring as shown below.

- (1) Connect the signal output cable to the 3WAY connector and thread the cable through 3 cable support hooks to be fixed.
- (2) Clamp the signal output cable by the re-use clamber.
- (3) Connect the power cable (3 core) to the OP1 connector and protective ground screw.
- (4) Band the power cable (3 core) and power supply cable together with the clamber (field supply).

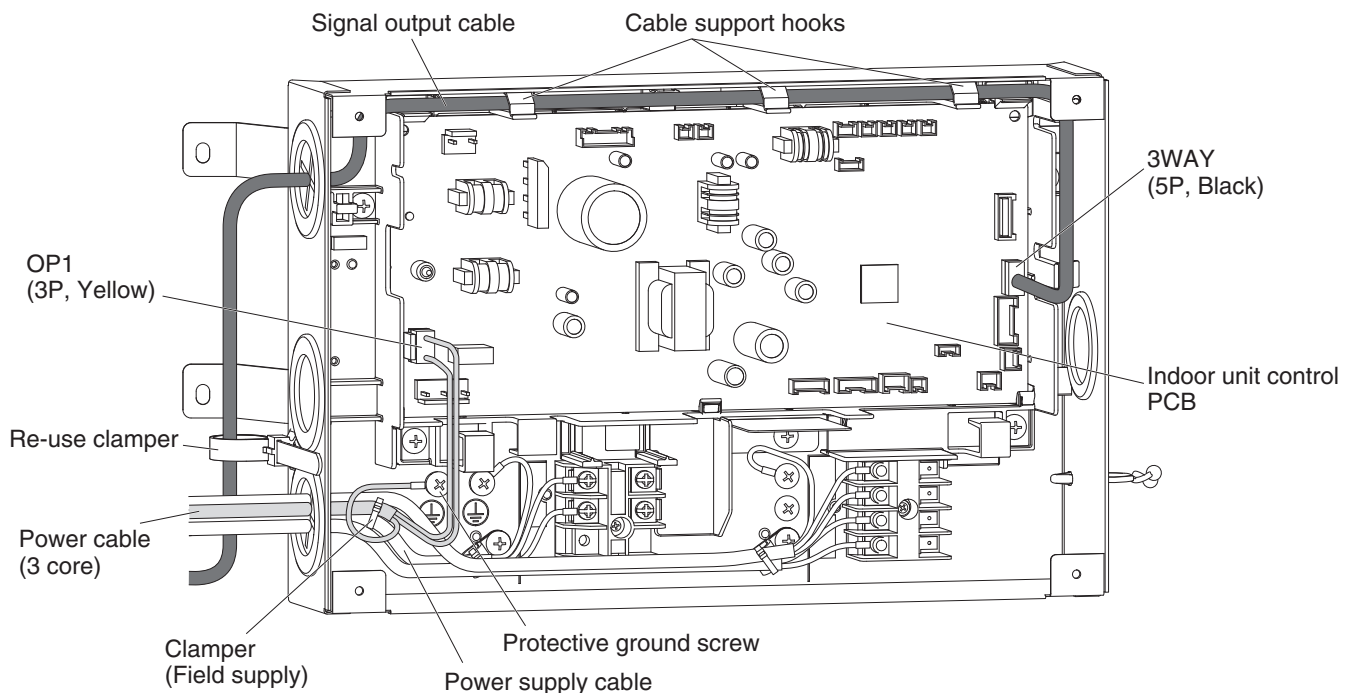

**< In the case of Solenoid Valve Kit (CZ-P456HR3, CZ-P656HR3, CZ-P856HR3, CZ-P4160HR3) >**

Read the Installation Instructions of Solenoid Valve Kit before installation.

1. Install the Solenoid Valve Relay Kit as shown below.

NOTE 1: When connecting to the grid system ceiling, install the Solenoid Valve Relay Kit after installation of the indoor unit in the ceiling.

In respect of the ceiling other than the grid system, install it near the inspection hole.

NOTE 2: Be aware that the Solenoid Valve Relay Kit should be installed in the direction as shown in figure below.

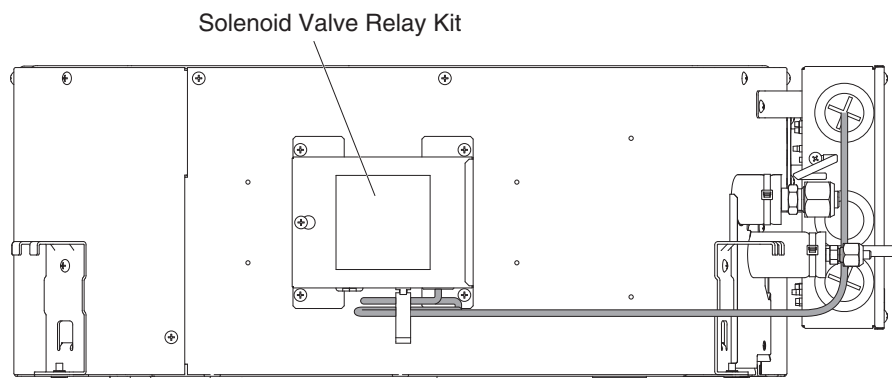

2. Make wiring as shown below.

(1) Connect the 3-Way connecting wire to the 3WAY connector and thread the wire through 3 cable support hooks to be fixed.

(2) Clamp the 3-Way connecting wire by the re-use clamber.

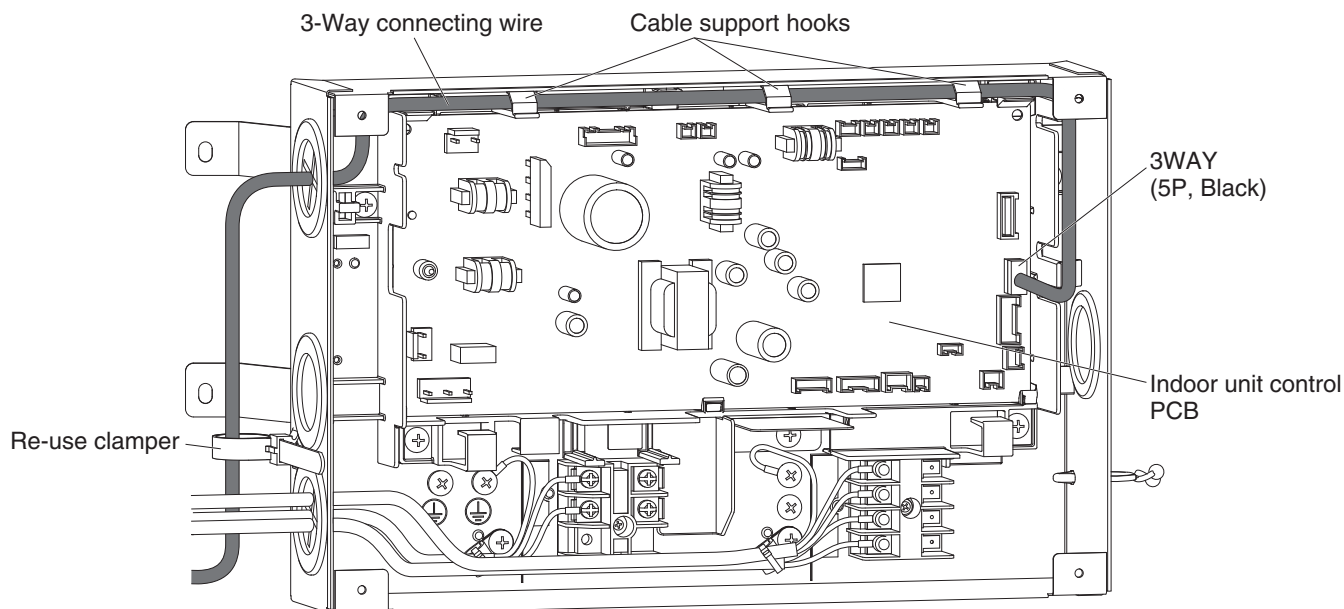

## ■ When connecting to the optional parts

### < Connecting to Schedule Timer >

Read the Installation Instructions of Schedule Timer before installation.

1. Connect the schedule timer power wiring to the T10 connector and functional ground screw.
2. Connect the schedule timer communications wiring to the terminal board and functional ground screw.
3. Band the schedule timer communications wiring, schedule timer power wiring and inter-unit control wiring together with the clammer (field supply).

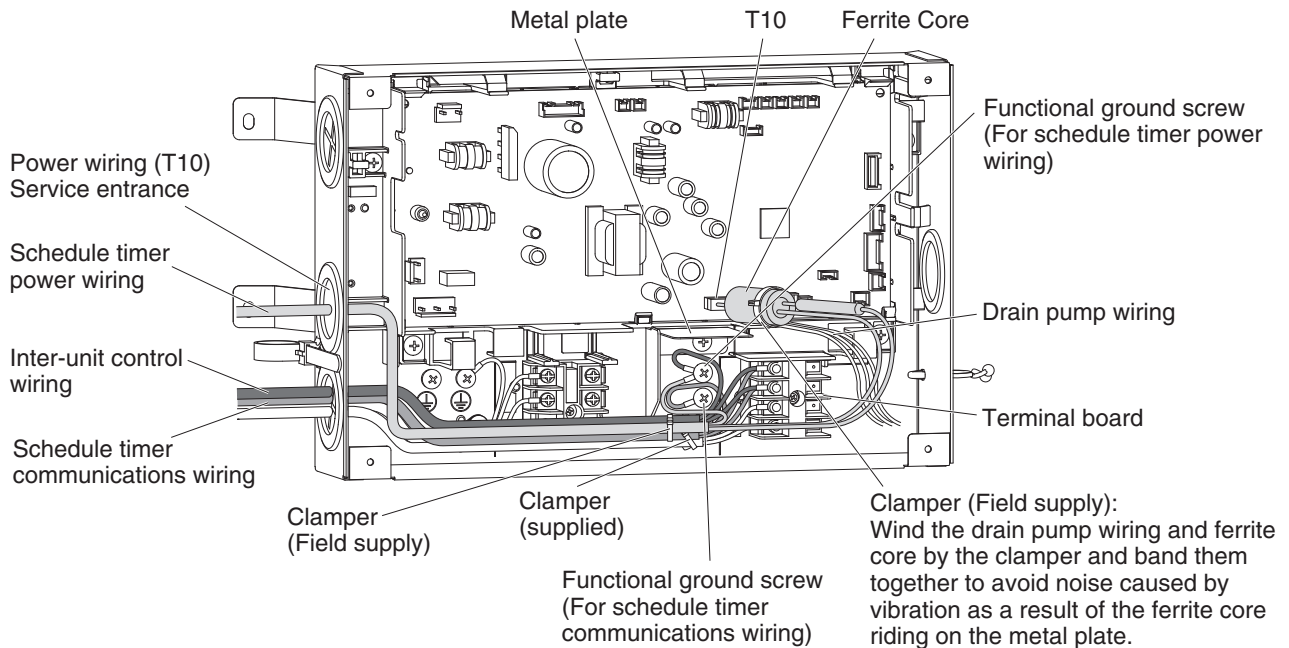

### < Connecting to other optional parts >

Connect to each connector of the indoor unit control PCB as shown below.

NOTE: After connected to the connector, fix the wiring with 3 cable support hooks.

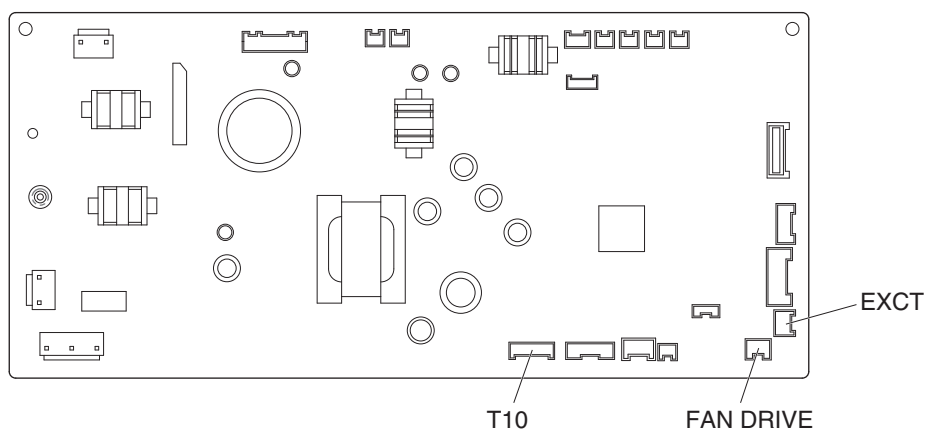

## 5. HOW TO PROCESS TUBING

Must ensure mechanical connections be accessible for maintenance purposes.

The liquid tubing side is connected by a flare nut, and the gas tubing side is connected by brazing.

### 5-1. Connecting the Refrigerant Tubing

#### Use of the Flaring Method

Many of conventional split system air conditioners employ the flaring method to connect refrigerant tubes that run between indoor and outdoor units. In this method, the copper tubes are flared at each end and connected with flare nuts.

#### Flaring Procedure with a Flare Tool

- (1) Cut the copper tube to the required length with a tube cutter. It is recommended to cut approx. 30 ~ 50 cm longer than the tubing length you estimate.
- (2) Remove burrs at each end of the copper tubing with a tube reamer or a similar tool. This process is important and should be done carefully to make a good flare. Be sure to keep any contaminants (moisture, dirt, metal filings, etc.) from entering the tubing.

#### NOTE

When reaming, hold the tube end downward and be sure that no copper scraps fall into the tube.

- (3) Remove the flare nut from the unit and be sure to mount it on the copper tube.
- (4) Make a flare at the end of the copper tube with a flare tool.

#### NOTE

When flared joints are reused, the flare part shall be re-fabricated.

A good flare should have the following characteristics:

- inside surface is glossy and smooth
- edge is smooth
- tapered sides are of uniform length

#### Caution Before Connecting Tubes Tightly

- (1) Apply a sealing cap or water-proof tape to prevent dust or water from entering the tubes before they are used.
  - (2) Be sure to apply refrigerant lubricant (ether oil) to the inside of the flare nut before making piping connections. This is effective for reducing gas leaks.
  - (3) For proper connection, align the union tube and flare tube straight with each other, then screw on the flare nut lightly at first to obtain a smooth match.
- Adjust the shape of the liquid tube using a tube bender at the installation site and connect it to the liquid tubing side valve using a flare.

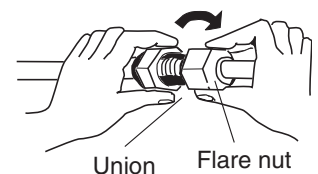
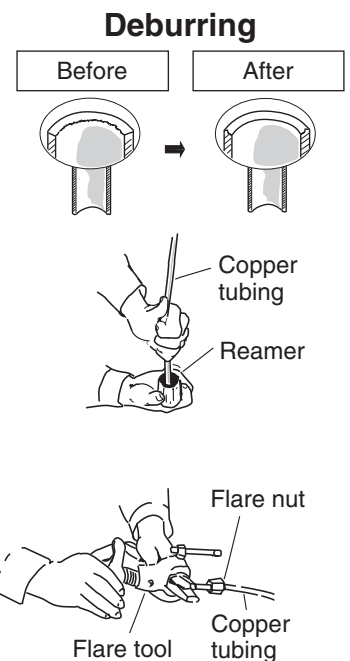

## Cautions During Brazing

- Replace air inside the tube with nitrogen gas to prevent copper oxide film from forming during the brazing process. (Oxygen, carbon dioxide and Freon are not acceptable.)
- Do not allow the tubing to get too hot during brazing. The nitrogen gas inside the tubing may overheat, causing refrigerant system valves to become damaged. Therefore allow the tubing to cool when brazing.
- Use a reducing valve for the nitrogen cylinder.
- Do not use agents intended to prevent the formation of oxide film. These agents adversely affect the refrigerant and refrigerant oil, and may cause damage or malfunctions.

## 5-2. Connecting Tubing Between Indoor and Outdoor Units

### NOTE

When connecting to the mini VRF 8HP, 10HP (outdoor units type LE1 only), select the main tube by using the following values. For details, refer to the installation instructions of the outdoor unit.

Indoor unit	15	22	28	36	45	56
Type Y3	0.084					

- (1) Tightly connect the indoor-side refrigerant tubing extended from the wall with the outdoor-side tubing.

### Indoor Unit Tubing Connection

Unit : mm

Indoor unit type	15	22	28	36	45	56
Gas tube	ø12.7					
Liquid tube	ø6.35					

- (2) To fasten the flare nuts, apply specified torque.
  - When removing the flare nuts from the tubing connections, or when tightening them after connecting the tubing, be sure to use two spanners. When tightening the flare nuts, use a torque wrench. If the flare nuts are over-tightened, the flare may be damaged, which could result in refrigerant leakage and cause injury or asphyxiation to room occupants.
  - For the flare nuts at tubing connections, be sure to use the flare nuts that were supplied with the unit, or else flare nuts for R410A, R32 (Type 2). The refrigerant tubing that is used must be of the correct wall thickness as shown in the following table.
 

Because the pressure is approximately 1.6 times higher than conventional refrigerant R22 pressure, the use of ordinary flare nuts (Type 1) or thin-walled tubes may result in tube rupture, injury, or asphyxiation caused by refrigerant leakage.
  - In order to prevent damage to the flare caused by over-tightening of the flare nuts, use the following table as a guide when tightening.

Tube diameter	Tightening torque (approximate)	Tube thickness
ø6.35 (1/4")	14 – 18 N · m {140 – 180 kgf · cm}	0.8 mm
ø9.52 (3/8")	34 – 42 N · m {340 – 420 kgf · cm}	0.8 mm
ø12.7 (1/2")	49 – 61 N · m {490 – 610 kgf · cm}	0.8 mm
ø15.88 (5/8")	68 – 82 N · m {680 – 820 kgf · cm}	1.0 mm

- When tightening the flare nut on the liquid tube, use an adjustable wrench with a nominal handle length of 200 mm.

### 5-3. Insulating the Refrigerant Tubing

#### Tubing Insulation

Must ensure that pipe-work shall be protected from physical damage.

- Thermal insulation must be applied to all units tubing, including distribution joint (field supply).
  - \* For gas tubing, the insulation material must be heat resistant to 120°C or above. For other tubing, it must be heat resistant to 80°C or above.

Insulation material thickness must be 10 mm or greater.

If the conditions inside the ceiling exceed DB 30°C and RH 70%, increase the thickness of the gas tubing insulation material by 1 step.

#### Two tubes arranged together

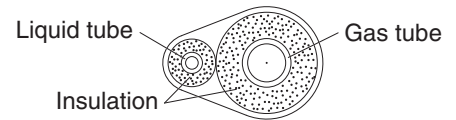

#### ⚠ CAUTION

**If the exterior of the outdoor unit valves has been finished with a square duct covering, make sure you allow sufficient space to access the valves and to allow the panels to be attached and removed.**

#### Additional Precautions For R32 Models

⚠ Ensure to do the re-flaring of pipes before connecting to units to avoid leaking.

To prevent the ingress of moisture into the joint which could have the potential to freeze and then cause leakage, the joint must be sealed with suitable silicone and insulation material. The joint should be sealed on both liquid and gas side.

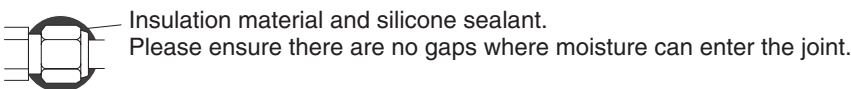

Silicone Sealant must be neutral cure and ammonia free. Use of silicone containing ammonia can lead to stress corrosion on the joint and cause leakage.



## Taping the flare nuts

Wind the insulating tape around the flare nuts at the gas / liquid tube connections. Then cover up the tubing connections with the flare insulator.

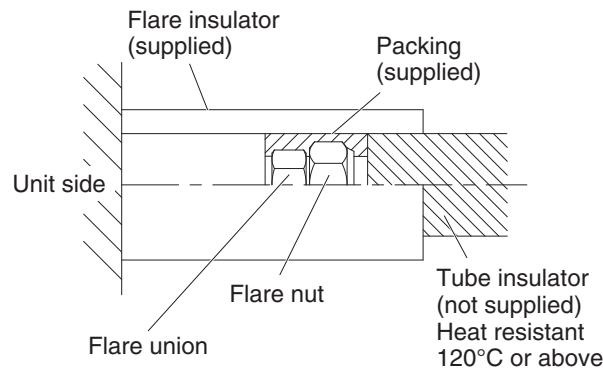

## Insulation material

The material used for insulation must have good insulation characteristics, be easy to use, be age resistant, and must not easily absorb moisture.

### NOTE

If noise bothers you from the area between indoor and outdoor units' connection pipes, it is effective to wind the soundproofing materials (field supply) to reduce noise.



### CAUTION

**After a tube has been insulated, never try to bend it into a narrow curve because it can cause the tube to break or crack.**

**Never grasp the drain or refrigerant connecting outlets when moving the unit.**

## 5-4. Taping the Tubes

- (1) At this time, the refrigerant tubes (and electrical wiring if local codes permit) should be taped together with armoring tape in 1 bundle. To prevent condensation from overflowing the drain pan, keep the drain hose separate from the refrigerant tubing.
- (2) Wrap the armoring tape from the bottom of the outdoor unit to the top of the tubing where it enters the wall. As you wrap the tubing, overlap half of each previous tape turn.
- (3) Clamp the tubing bundle to the wall, using 1 clamp approx. each meter.
- (4) Limited to Oceania only :

Interconnecting refrigerant pipework, i.e. pipework external to the unitary components, should be marked with a Class label (see right figure) every two metres where the pipework is visible.

Label size is 50 mm × 50 mm.

This includes pipework located in a ceiling space or any void which a person may access for maintenance or repair work within that space.

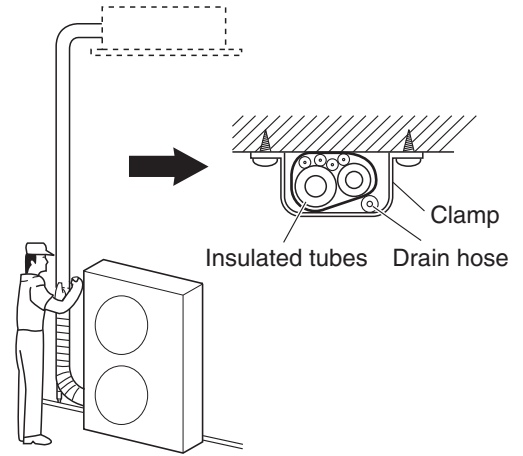

### NOTE

Do not wind the armoring tape too tightly since this will decrease the heat insulation effect. Also ensure that the condensation drain hose splits away from the bundle and drips clear of the unit and the tubing.

## 5-5. Finishing the Installation

After finishing insulating and taping over the tubing, use sealing putty to seal off the hole in the wall to prevent rain and draft from entering.

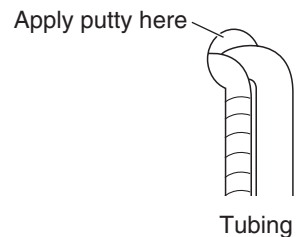

## 6. HOW TO INSTALL THE TIMER REMOTE CONTROLLER OR HIGH-SPEC WIRED REMOTE CONTROLLER (OPTIONAL PART)

### NOTE

Refer to the Installation Instructions attached to the optional Timer Remote Controller or optional High-spec Wired Remote Controller.

# 7. HOW TO INSTALL THE PANEL FOR CASSETTE

## Accessories

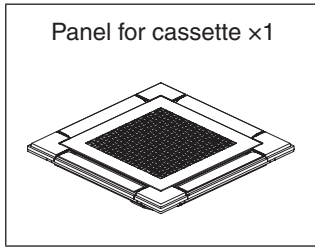

### 7-1. Preparation for Panel for Cassette Installation

#### (1) Checking the unit position

- 1) Check that the ceiling hole is within this range: 585 × 585 mm ~ 600 × 600 mm
- 2) Confirm that the position of the indoor unit and the ceiling as shown in the diagram. If the positions of the ceiling surface and unit do not match, air leakage, water leakage, flap operation failure, or other problems may occur.
- 3) After checking, remove the full-scale installation diagram.

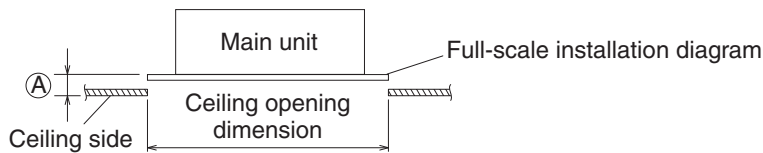

- Ⓐ Be sure to necessarily make a space within the range of 13 ~ 18 mm.  
If not within this range, malfunction or other problems may occur.

### ⚠ CAUTION

- Never place the panel face-down.  
Either hang it vertically or place it on top of a projecting object. Placing it face-down will damage the surface.
- Do not touch the flap or apply force to it. (This may cause flap malfunction.)

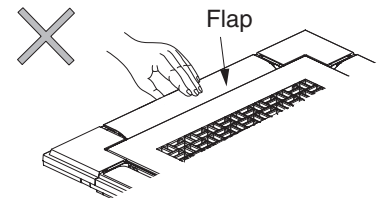

### 7-2. How to Install the Panel for Cassette

#### (1) Removing the air intake grille

- 1) Remove the 2 screws on the latch of the air intake grille. (Reattach the air intake grille after installation of the panel for cassette.)
- 2) Slide the air intake grille catches in the direction shown by the arrows ① to open the grille.

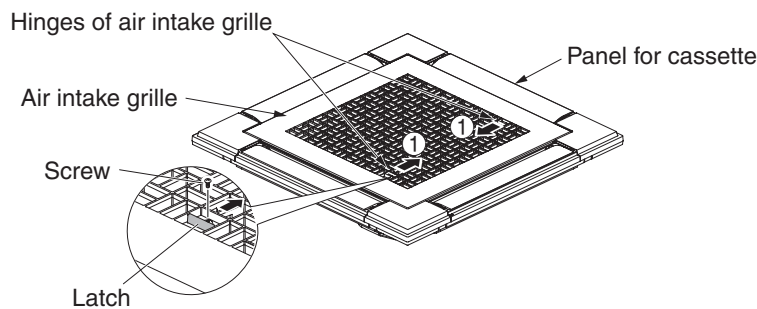

- 3) With the air intake grille opened, remove the grille hinge from the panel for cassette by sliding it in the direction shown by the arrow ②. (Reattach the air intake grille after installation of the panel for cassette.)

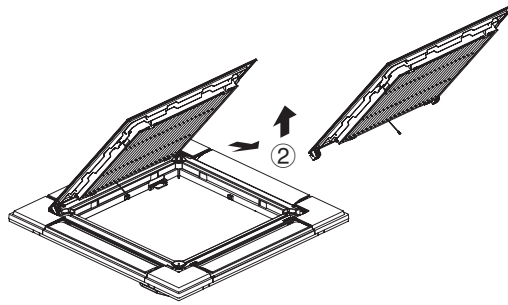

(2) Removing the corner cover

Push the latches on the corner cover in the direction of the arrow ① and remove them by sliding in the direction of the arrow ②.

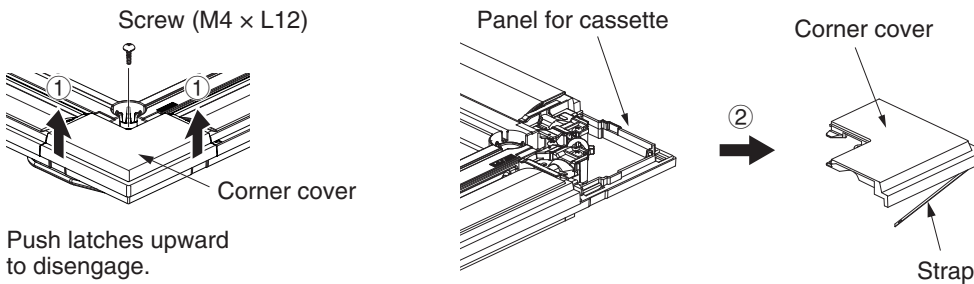

(3) Installing the panel for cassette

The power must be turned ON in order to change the flap angle. (Do not attempt to move the flap by hand. Doing so may damage the flap.)

- 1) Hang the temporary latches on the inside of the panel for cassette to the receptacle on the unit to temporarily attach the panel for cassette in place.
  - The panel for cassette must be installed in the correct direction relative to the unit. Align the REF. PIPE and DRAIN marks on the panel for cassette corner with the correct positions on the unit.
  - When removing the panel for cassette, push the temporary latches outward while holding the panel for cassette.

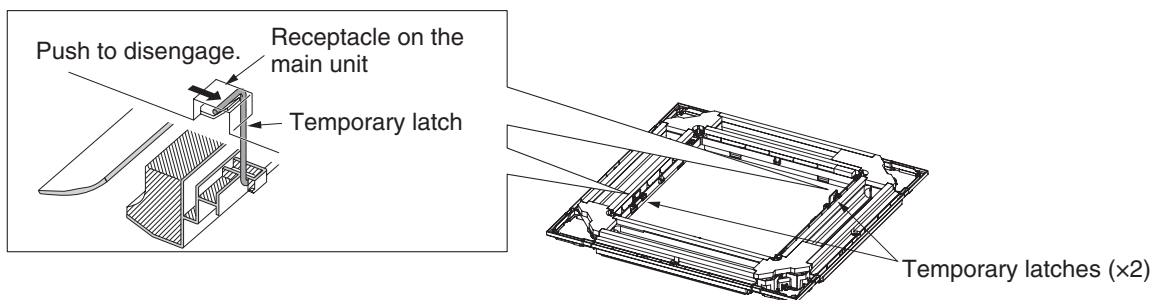

2) Align the panel installation holes and the unit screw holes.

3) Tighten the provided washer head screws at the 4 panel installation locations so that the panel is attached tightly to the unit.

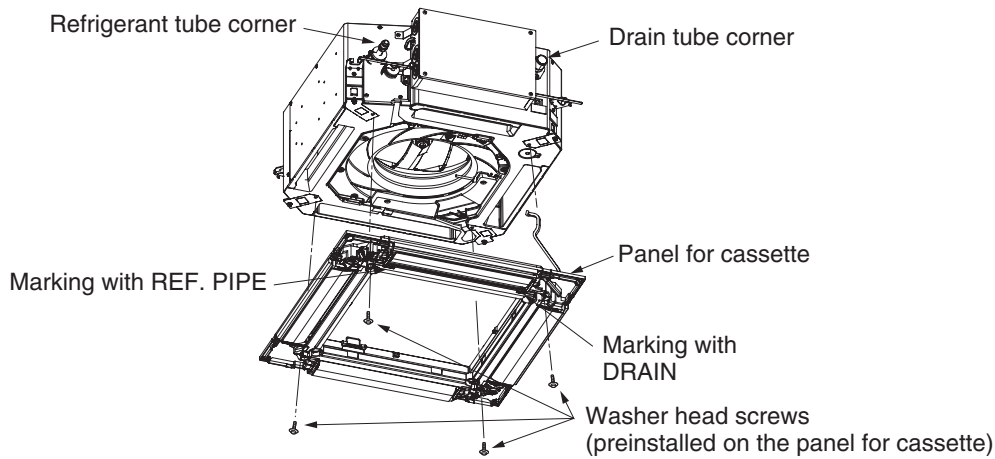

4) Check that the panel is attached tightly to the ceiling.

- At this time, make sure that there are no gaps between the unit and the panel for cassette, or between the panel for cassette and the ceiling surface.
- If there is a gap between the panel and the ceiling, leave the panel for cassette attached and make fine adjustments to the installation height of the unit to eliminate the gap with the ceiling.

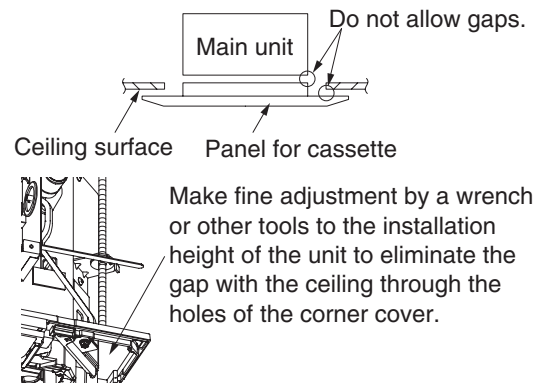

**CAUTION**

- If the screws are not sufficiently tightened, trouble such as that shown in the figure may occur.  
Be sure to tighten the screws securely.

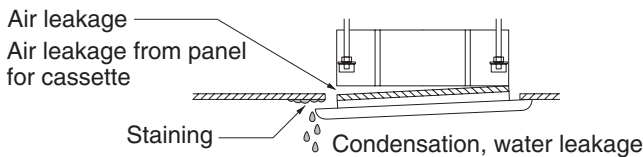

- If a gap remains between the ceiling surface and the panel for cassette even after the screws are tightened, adjust the height of the unit again.

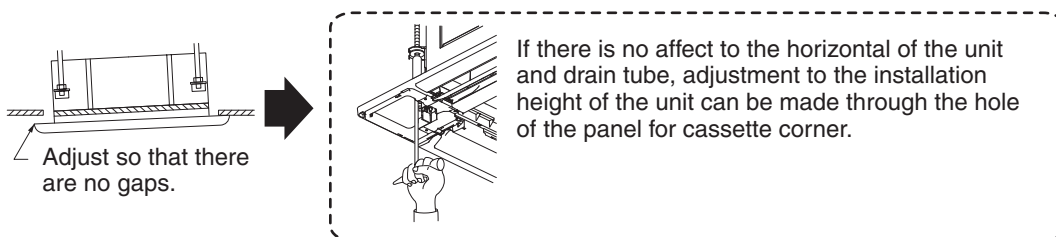

#### (4) Wiring the Panel for Cassette

- 1) Open the cover of the electrical component box for the indoor unit control PCB.
- 2) Connect the 22P connector (black) from the panel for cassette to the connector on the indoor unit control PCB in the unit electrical component box. In this case, expose the cutout section of the tube for the wiring protection to the outside from the electrical component box and fix it with the clammer attached to the electrical component box.

- Insert connector lock facing PCB edge until it is locked in place. (If not connected completely, the Auto Flap will not operate and “P09” is displayed on the remote controller.)
- Check that the wiring connector is not caught between the electrical component box and the cover.
- Check that the wiring connector is not caught between the unit and the panel for cassette.

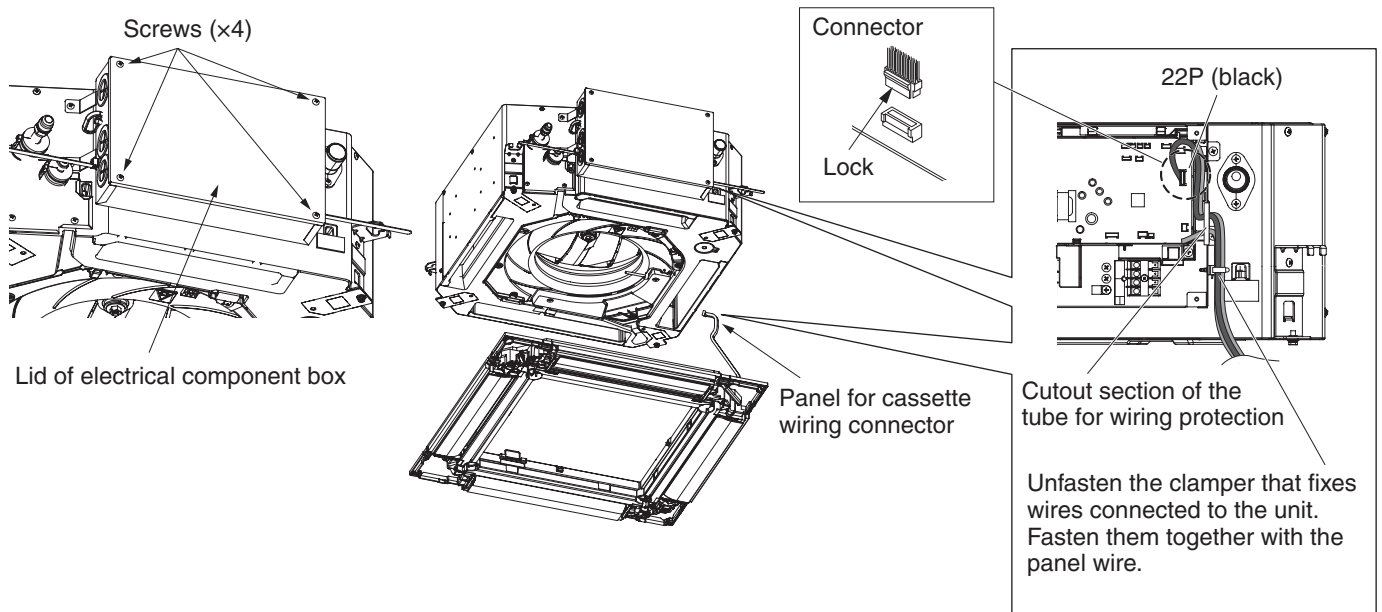

#### (5) How to Attach the Corner & Air Intake Grille

##### A. Attaching the corner cover

- 1) Check that the safety strap from the corner cover is fastened to the panel for cassette pin, as shown in the figure.
- 2) Use the supplied screws to attach the corner cover to the panel for cassette.

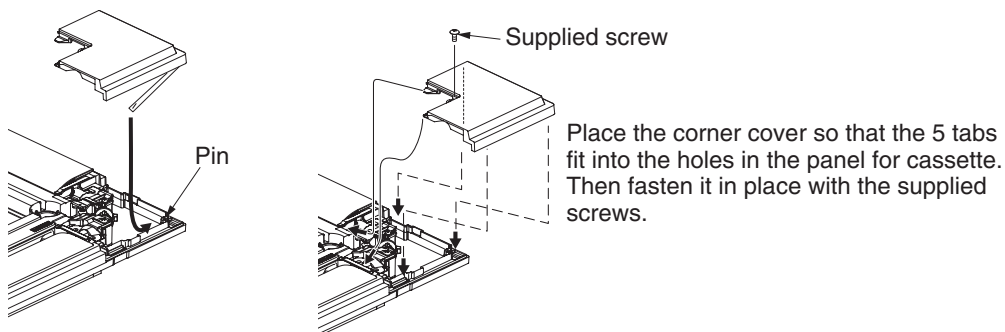

##### B. Attaching the air intake grille

- To install the air intake grille, follow the steps for “(1) Removing the air intake grille” in the reverse order. By rotating the air intake grille, it is possible to attach the grille onto the panel for cassette from any of 4 directions. Coordinate the directions of the air intake grilles when installing multiple units, and change the directions according to customer’s requests.
- When attaching the air intake grille, be careful that the flap lead wire does not become caught.

- Be sure to attach the safety strap that prevents the air intake grille from dropping off to the panel for cassette unit as shown in the figure.

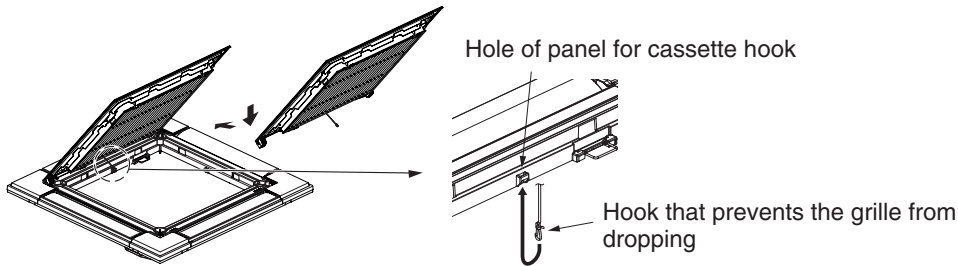

- With this panel for cassette, the directions of the air intake grille lattices when installing multiple units, and the position of the label showing the company name on the corner panel, can be changed according to customer's requests, as shown in the figure. However, the wireless signal receiver can only be installed at the refrigerant-tubing corner of the ceiling unit.

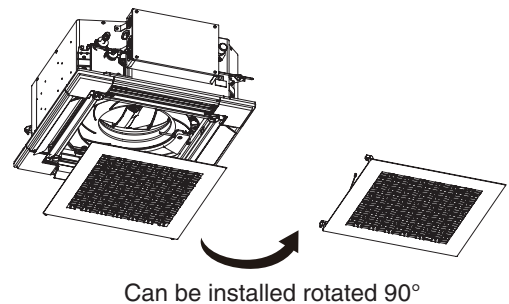
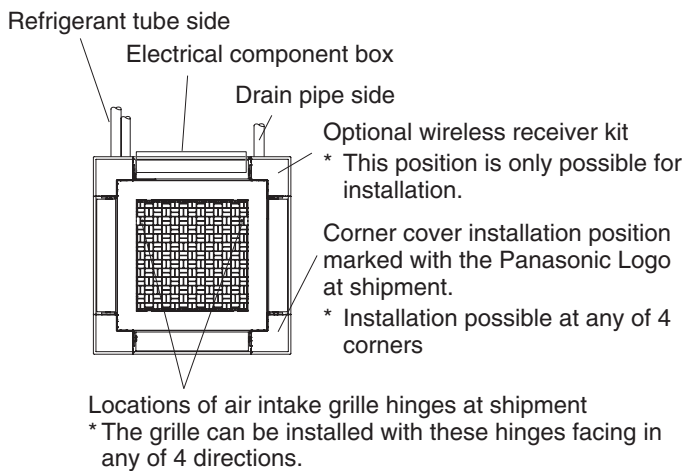

### 7-3. Others

#### (1) Checking After Installation

- 1) Check that there are no gaps between the unit and the panel for cassette, or between the panel for cassette and the ceiling surface.  
\* Gaps may cause water leakage and condensation.
- 2) Check that the wiring is securely connected.  
\* If it is not securely connected, the auto flap will not operate.  
(“P09” is displayed on the remote controller.)  
In addition, the water leakage and condensation may occur.

#### (2) Operating the Wireless Remote Controller

For details of installation, refer to the Installation Instructions attached to the optional Wireless Remote Controller.

#### (3) Setting the Flap Separately

The 4-air outlet flap can be adjusted separately during operation. When not adjusted separately, all flaps operate in the same manner.

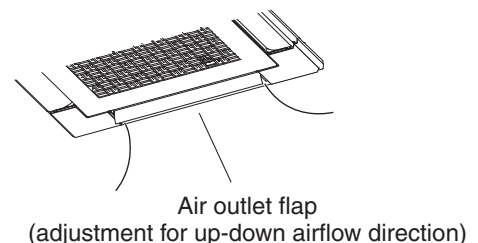







### <Procedure of CZ-RTC5B>

Refer to Section “Flap Setting for Each Air Outlet” in the Operating Instructions attached to the optional High-spec Wired Remote Controller.

### <Procedure of CZ-RTC4>



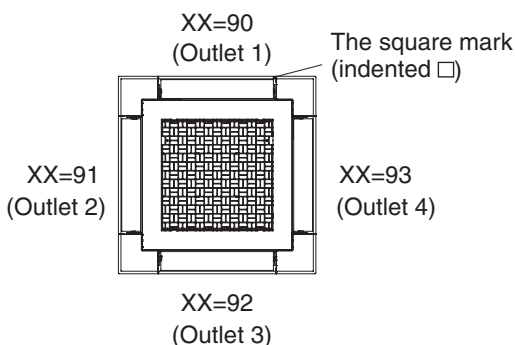
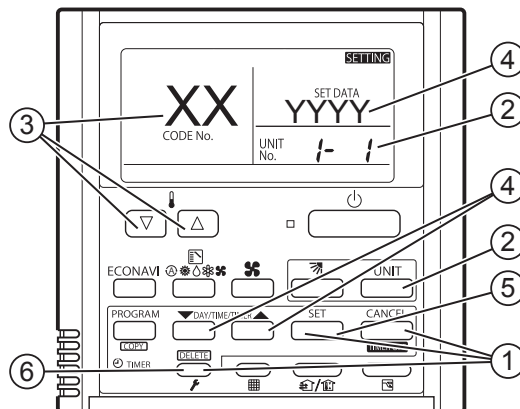

Stop the system before performing these steps.

- ① Press and hold the ,  and  buttons simultaneously for 4 seconds or longer.
- ② If group control is in effect, press the  button to set. At this time, the fan at the indoor unit begins and select the address (unit No.) of the indoor unit operating.
- ③ Designate the item code “XX” by adjusting the Temperature Setting / buttons.





- ④ Press the timer time  buttons to select the desired setting data.

#### \* Setting data “YYYY”

Setting data	Flap position during operation
0000	Without separate setting
0001	Swing
0002	Move to position  and stay
0003	Move to position  and stay
0004	Move to position  and stay
0005	Move to position  and stay
0006	Move to position  and stay

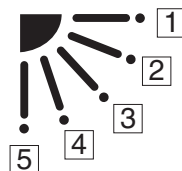
#### Flap position





- ⑤ Press the  button.  
(The display stops blinking and remains lit, and setting is completed.)  
If you wish to change the selected indoor unit, follow Step ②.
- ⑥ Press the  button to return to normal remote controller display.





## <Procedure of CZ-RTC6 series>

Stop the system before performing these steps.

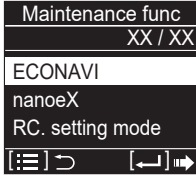



- Keep pressing the ,  and  buttons simultaneously for 4 or more seconds.  
The "Maintenance func" screen appears on the LCD display.



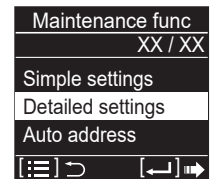

- Press the  or  button to see each menu.  
Select "Detailed settings" on the LCD display and press the  button.

The "Detailed settings" screen appears on the LCD display.

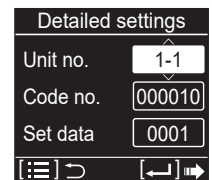

- Select the "Unit no." by pressing the  or  button.  
After selecting "Unit no.", press the  button and proceed to Step ④.  
If the  button is pressed, proceed to Step ⑥.



- Keep pressing the  button for 2 seconds or more during selecting "Code no."  
Change the "Code no." one digit at a time so that it becomes [0000XX] along with the following procedures.

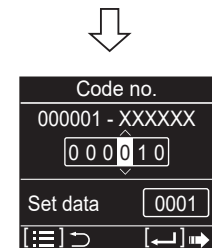
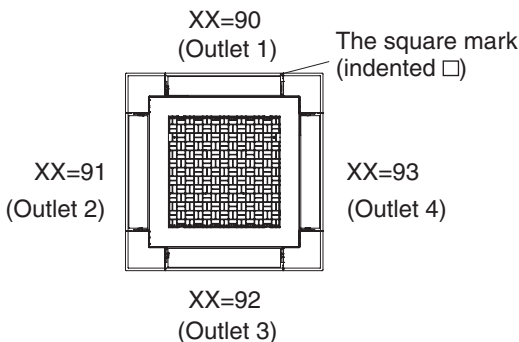







Fig. A

Change the value by pressing the  or  button.  
After changing the value, press the  button and set the next digit.

Change the value by pressing the  or  button.  
After changing the value, press the  button and set the next digit.

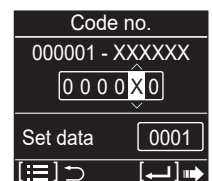





Fig. B

Change the value by pressing the  or  button.  
After changing all digits, press the  button and proceed to Step ⑤.

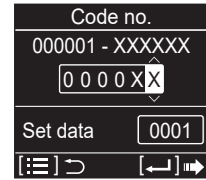









Fig. C

⑤ Select one of the Setting Data “YYYY” by pressing the  or  button.

\* Setting data “YYYY”

Setting data	Flap position during operation
0000	Without separate setting
0001	Swing
0002	Move to position  and stay
0003	Move to position  and stay
0004	Move to position  and stay
0005	Move to position  and stay
0006	Move to position  and stay

Flap position

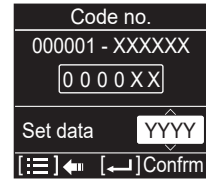
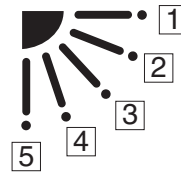







Fig. D

After selecting “Set data”, press the  button. (If setting continuously, follow the procedures from Fig. A.)

If you wish to change the selected indoor unit or finish setting, press the  button (the display returns to Step ③).

⑥ If the  button is pressed under the display Step ③, the following display (Detailed setting-end screen) appears.  
Then select “YES” by pressing the  or  button and press the  button.



## 8. HOW TO INSTALL WIRELESS REMOTE CONTROLLER

### NOTE

Refer to the Installation Instructions attached to the optional Wireless Remote Controller.

## 9. PRECAUTIONS ON TEST RUN

- Request that the customer be present when the test run is performed.  
At this time, explain the operation manual and have the customer perform the actual steps.
- Check that the 220 – 240 VAC power is not connected to the inter-unit control wiring connector terminal.
  - \* If 220 – 240 VAC is accidentally applied, the indoor unit control PCB fuse will blow in order to protect the PCB.  
In this case, make the wiring correctly.  
Then disconnect the 2P connectors (OC) that are connected to the indoor unit control PCB, and replace them with 2P connectors (EMG).  
If operation is still not possible after changing the brown connectors, cut the jumper on the indoor unit control PCB.  
(Be sure to turn the power OFF before performing this work.)

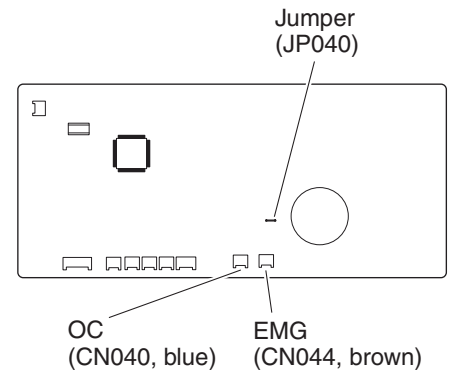

# 10. CHECKLIST AFTER INSTALLATION WORK

Work List	No.	Content	Check <input checked="" type="checkbox"/>	Possibility of Failure & Checkpoint	
Installation	1	Are the indoor units installed following the content of Section "2. SELECTING THE INSTALLATION SITE"?	<input type="checkbox"/>	There is a possibility of light injure or loss of property.	
Tubing & Wiring	2	In the case of multiple installation: Is there a wrong tubing connection with another system?	<input type="checkbox"/>	The unit is inoperated or the refrigerant flows into the inoperative unit and the leakage is expected. Check if there is a wrong tubing or wiring connection with another system.	
	3	In the case of multiple installation: Is there a wrong wiring connection with another system?	<input type="checkbox"/>		
	4	Is the earth leakage circuit breaker (all-pole switching function provided) installed?	<input type="checkbox"/>	Power failure or short circuit may cause electric shock or fire. Check installation work and ground wire work.	
	5	Is there any wrong installation of optional parts or wrong wiring?	<input type="checkbox"/>		
	6	Was the ground wire work performed?	<input type="checkbox"/>		
	7	Are there any wrong power supply wiring, wrong connection wire, wrong signal wire or loose screw?	<input type="checkbox"/>		
	8	Is the thickness of wire in accordance with rule?	<input type="checkbox"/>		
	9	Is the power-supply voltage equal to the nameplate of the unit?	<input type="checkbox"/>		
	10	Was the check of the airtight test, flared tube fitting and gas leakage on the welded portion performed?	<input type="checkbox"/>		If the gas leakage occurs, the unit quality not only becomes inferior but affects environment. Repair it as quickly as possible.
	Drain Check	11	Has the adhesive been applied to the drain connecting portion (resin portion) of the indoor unit?		<input type="checkbox"/>
12		Is there water leakage?	<input type="checkbox"/>	Since there is a possibility of water drain, repair the drain pipe if the drain failure or water drain occurs.	
13		Indoor unit drain pipe has a downward gradient (1/100 or more) by rule. Is the drain water flowing smoothly?	<input type="checkbox"/>		
Heat Insulation	14	Was the heat insulation work at a suitable location including the flared tube fitting (refrigerant tube & drain pipe) performed properly?	<input type="checkbox"/>	The quality of unit not only becomes inferior but there is a possibility of the water drain. So, perform the heat insulation work properly.	
Test Run	15	Did the abnormal sound occur?	<input type="checkbox"/>	Check if there is a fan contact or distortion of the indoor unit.	
	16	Did the cool and warm airflow discharge from the indoor unit?	<input type="checkbox"/>	Check if the unit does not operate or there is a wrong tubing or wiring connection with another system.	

# 11. APPENDIX

## ■ Care and Cleaning

### ⚠ WARNING

- For safety, be sure to turn the air conditioner off and also to disconnect the power before cleaning.
- Do not pour water on the indoor unit to clean it. This will damage the internal components and cause an electric shock hazard.

### Air intake and outlet side (Indoor unit)

Clean the air intake and outlet side of the indoor unit with a vacuum cleaner brush, or wipe them with a clean, soft cloth.

If these parts are stained, use a clean cloth moistened with water. When cleaning the air outlet side, be careful not to force the vanes out of place.

### ⚠ CAUTION

- Never use solvents or harsh chemicals when cleaning the indoor unit. Do not wipe plastic parts using very hot water.
- Some metal edges and the fins are sharp and may cause injury if handled improperly; be especially careful when you clean these parts.
- The internal coil and other components of outdoor unit must be cleaned regularly. Consult your dealer or service center.

### Air filter

The air filter collects dust and other particles from the air and should be cleaned at regular intervals or when the filter indication (🌀) on the display of the remote controller (wired type) shows that the filter needs cleaning. If the filter gets blocked, the efficiency of the air conditioner drops greatly.

Type	Y3
Period	6 months

### ● After Cleaning

1. After the air filter is cleaned, reinstall it in its original position.  
Be sure to reinstall in reverse order.
2. [In the case of Timer Remote Controller]  
Press the Filter reset button.  
The 🌀 (Filter) indicator on the display goes out.

Timer Remote Controller

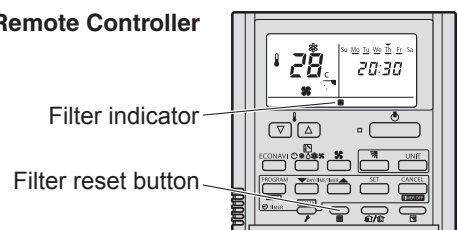

[In the case of High-spec Wired Remote Controller and Wired Remote Controller]

Refer to the Operating Instructions attached to the optional High-spec Wired Remote Controller or optional Wired Remote Controller.

High-spec Wired Remote Controller

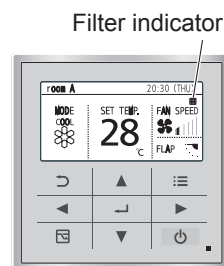

Wired Remote Controller

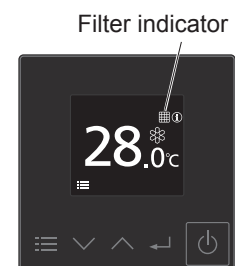

**NOTE**

The frequency with which the filter should be cleaned depends on the environment in which the unit is used.

Clean the filter frequently for best performance in the area of dusty or oil spots regardless of filter status.

**<How to clean the filter>**

1. Remove the air filter from the air intake grille.
2. Use a vacuum cleaner to remove light dust. If there is sticky dust on the filter, wash the filter in lukewarm, soapy water, rinse it in clean water, and dry it.

**<How to remove the filter>****4-Way Cassette 60 × 60:**

1. Use a screwdriver to remove the bolt screw on each side for the two latches. (Be sure to reattach the two bolt screws after cleaning.)
2. Slide the latches of the air intake grille in the direction of the inside to open the grille.
3. The air intake grille opens downward.

**⚠ CAUTION**

- When cleaning the air filter, never remove the safety strap. If it is necessary to remove it for servicing and maintenance inside, be sure to reinstall the safety strap securely (hook on the grille side) after the work.
  - When the filter has been removed, rotating parts (such as the fan), electrically charged areas, etc. will be exposed in the unit's opening. Bear in mind the dangers that these parts and areas pose, and proceed with the work carefully.
4. Push the bottom of the air filter up and pull it toward you. The air filter will be disengaged.

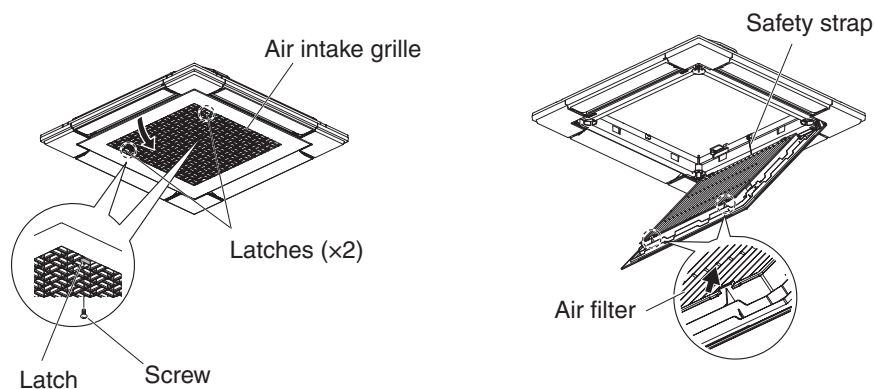
**⚠ CAUTION**

- Certain metal edges and the condenser fins are sharp and may cause injury if handled improperly; special care should be taken when you clean these parts.
- Periodically check the outdoor unit to see if the air outlet or air intake is clogged with dirt or soot.
- The internal coil and other components must also be cleaned periodically. Consult your dealer or service center.

**Care: After a prolonged idle period**

Check the indoor and outdoor unit air intakes and outlets for blockage; if there is a blockage, remove it.

**Care: Before a prolonged idle period**

- Operate the fan for half a day to dry out the inside.
- Disconnect the power supply and also turn off the circuit breaker.
- Clean the air filter and replace it in its original position.
- Outdoor unit internal components must be checked and cleaned periodically. Contact your local dealer for this service.

**■ Troubleshooting**

If your air conditioner does not work properly, first check the following points before requesting service. If it still does not work properly, contact your dealer or a service center.

● **Indoor unit**

Symptom		Cause
Noise	Sound like streaming water during operation or after operation	<ul style="list-style-type: none"> <li>● Sound of refrigerant liquid flowing inside unit</li> <li>● Sound of drainage water through drain pipe</li> </ul>
	Cracking noise during operation or when operation stops.	Cracking sound due to temperature changes of parts
Odor	Discharged air is smelled during operation.	Indoor odor components, cigarette odor and cosmetic odor accumulated in the air conditioner and its air is discharged. Unit inside is dusty. Consult your dealer.
Dewdrop	Dewdrop gets accumulated near air discharge during operation	Indoor moisture is cooled by cool wind and accumulated by dewdrop.
Fog	Fog occurs during operation in cooling mode. (Places where large amounts of oil mist exist at restaurants.)	<ul style="list-style-type: none"> <li>● Cleaning is necessary because unit inside (heat exchanger) is dirty. Consult your dealer as technical engineering is required.</li> <li>● During defrost operation</li> </ul>
Fan is rotating for a while even though operation stops.		<ul style="list-style-type: none"> <li>● Fan rotating makes operation smoothly.</li> <li>● Fan may sometimes rotate because of drying heat exchanger due to settings.</li> <li>● Fan may sometimes rotate in internal cleaning operation mode for a while.</li> </ul>
Wind-direction changes while operating. Wind-direction setting cannot be made. Wind-direction cannot be changed.		<ul style="list-style-type: none"> <li>● When air discharge temperature is low or during defrost operation, horizontal wind flow is made automatically.</li> <li>● Flap position is occasionally set up individually.</li> </ul>
When wind-direction is changed, flap operates several times and stops at designated position.		When wind-direction is changed, flap operates after searching for standard position.
Dust		Dust accumulation inside indoor unit is discharged.
Poor cooling or heating performance		<p>The indoor unit is initially designed to control the indoor temperature detected by the built-in room sensor inside the indoor unit. Due to indoor unit installation position, however, the built-in sensor may occasionally sense temperature improperly; for example, temperature difference between the ceiling and floor, lighting apparatus, electric fan, windows or waist-high partition walls, etc. In this case, the unit does not operate properly at the desired temperature. You may change the use of the temperature sensor inside the indoor unit to that of the remote controller. Then the desired room temperature can be controlled properly. For details, consult your dealer.</p>



## ● Check Before Requiring Services

Symptom	Cause	Remedy
Air conditioner does not run at all although power is turned on.	Power failure or after power failure	Press ON/OFF operation button on remote controller again.
	Operation button is turned off.	<ul style="list-style-type: none"> <li>● Switch on power if breaker is turned off.</li> <li>● If breaker has been tripped, consult your dealer without turning it on.</li> </ul>
	Fuse blow out.	If blown out, consult your dealer.
Poor cooling or heating performance	Air intake or air discharge port of indoor and outdoor units is clogged with dust or obstacles.	Remove dust or obstruction.
	Fan speed switch is set to "Low".*	Change to "Medium" or "High".*
	Improper temperature settings	See Section "■ Tips for Energy Saving".
	Room is exposed to direct sunlight in cooling mode.	
	Doors and /or windows are open.	
	Air filter is clogged.	See Section "■ Care and Cleaning".
	Too much heat sources in room in cooling mode.	Use minimum heat sources and in a short time.
	Too many people in room in cooling mode.	Reduce temperature settings or change to "Medium" or "High".*

\* Fan speed display on the remote controller

High :  (CZ-RTC4),  (CZ-RTC5B, CZ-RTC6 series)

Medium :  (CZ-RTC4),  (CZ-RTC5B, CZ-RTC6 series)

Low :  (CZ-RTC4),  (CZ-RTC5B, CZ-RTC6 series)

- If the P08 alarm and inspection mark are displayed on the remote controller and the fan automatically operates and does not stop even when you press ON/OFF operation button on remote controller, R32 refrigerant leakage detection sensor connected to the indoor unit has detected refrigerant leakage. In such a case, do not turn off the earth leakage circuit breaker, ventilate the room, and contact the service dealer immediately.

If your air conditioner still does not work properly although you checked the points as described above, first stop the operation and turn off the power switch. Then contact your dealer and report the serial number and symptom. Never repair your air conditioner by yourself since it is very dangerous for you to do so. You also report if the inspection mark  and the letters E, F, H, J, L, P in combination with the numbers appear on the LCD of the remote controller.



## ■ Tips for Energy Saving

### Avoid

- **Do not block the air intake and outlet of the unit. If either is obstructed, the unit will not work well, and may be damaged.**
- Do not let direct sunlight into the room. Use sunshades, blinds or curtains. If the walls and ceiling of the room are warmed by the sun, it will take longer to cool the room.

### Do

- Always try to keep the air filter clean. (See Section “■ Care and Cleaning”.) A clogged filter will impair the performance of the unit.
- To prevent conditioned air from escaping, keep windows, doors and any other openings closed.

### NOTE

#### **Should the power fail while the unit is running**

If the power supply for this unit is temporarily cut off, the unit will automatically resume operation once power is restored using the same settings before the power was interrupted.

## **Important Information Regarding The Refrigerant Used**

### NOTE

Refer to the Installation Instructions attached to the outdoor unit.

